































































Serie 55000

 55000 Pag. 2.7	 55010 Pag. 2.7	 50010N Pag. 2.7	 50020N Pag. 2.8	 50030N Pag. 2.8	 55040 Pag. 2.9	 50050N Pag. 2.9	 55050 Pag. 2.9	 50055N Pag. 2.9
 50465N Pag. 2.10	 55060 Pag. 2.10	 55106 Pag. 2.10	 55111 Pag. 2.10	 55116 Pag. 2.11	 55126 Pag. 2.11	 55130 Pag. 2.11	 55140 Pag. 2.12	 55150 Pag. 2.12
 55160 Pag. 2.12	 55170 Pag. 2.13	 55175 Pag. 2.13	 55180 Pag. 2.13	 55211 Pag. 2.14	 55216 Pag. 2.14	 55223 Pag. 2.14	 55226 Pag. 2.15	 55230 Pag. 2.15
 55235 Pag. 2.15	 55237 Pag. 2.16	 55240 Pag. 2.16	 55310 Pag. 2.16	 55315 Pag. 2.17	 55320 Pag. 2.17	 55325 Pag. 2.17	 55330 Pag. 2.18	 55340 Pag. 2.18
 55345 Pag. 2.18	 55350 Pag. 2.19	 55360 Pag. 2.19	 55365 Pag. 2.19	 55500 Pag. 2.20	 55510 Pag. 2.20	 55520 Pag. 2.20	 55410 Pag. 2.20	 55420 Pag. 2.21
 55430 Pag. 2.21	 55440 Pag. 2.21	 50600 Pag. 2.22	 50610 Pag. 2.22	 50615 Pag. 2.23	 55620 Pag. 2.23	 50625 Pag. 2.23	 55625 Pag. 2.23	 50700N Pag. 2.24
 55700 Pag. 2.24	 55705 Pag. 2.24	 55800N Pag. 2.25	 55801 Pag. 2.26	 55802 Pag. 2.26	 50900N Pag. 2.27	 50980 Pag. 2.27	 50990 Pag. 2.27	 50006 Pag. 2.27

Serie 56000 MINI

 56010 Pag. 2.28	 56020 Pag. 2.28	 56040 Pag. 2.28	 56050 Pag. 2.29	 56115 Pag. 2.29	 56130 Pag. 2.29	 56215 Pag. 2.30	 56225 Pag. 2.30	 56230 Pag. 2.30
 56550 Pag. 2.30	 56900 Pag. 2.31	 56910 Pag. 2.31	 56920 Pag. 2.31	 56935 Pag. 2.32	 56945 Pag. 2.32	 56955 Pag. 2.32		

RACCORDI AUTOMATICI IN TECNOPOLIMERO

TECHNOPOLYMERIC PUSH-IN FITTING

KUNSTSTOFF STECKVERSCHRAUBUNGEN

RACCORDS INSTANTANÉS EN TECNOPOLYMÈRE

RACORDAJE AUTOMÁTICO EN TECNOPOLÍMERO

CONEXÕES PUSH-IN EM TECNOPOLÍMERO



Serie 55000

La serie 55.000 - 56000 Aignep, nata per rispondere alle esigenze più spinte nell'ambito dell'automazione pneumatica, offre al cliente più attento la possibilità di utilizzare un prodotto in tecnopolimero, abbinando a prestazioni elevate compattezza e leggerezza.

Gamma completa dal diam. 2 al 14 mm.

Principali vantaggi

- Connessione e sconnessione istantanea
- Pieno passaggio e tenuta al vuoto grazie a guarnizioni sagomate
- Tre tipologie di filettature, BSPP, BSPT (universal short) e Metrica
- Compattezza e riduzione dei pesi
- Gamma con figure specifiche per soddisfare la robotica più spinta
- Silicon Free

Applicazioni

- Robotica
- Automotive
- Industria tessile, imballaggio, manipolazione
- Circuiti aria compressa
- Acqua industriale
- Vuoto

The 55.000 - 56000 serie came up to answer the most extreme demands of pneumatic automation. It is a line in technopolymer, lighter and more compact which offers to demanding customers high performances.

Wide Range \varnothing 2 - 14 mm.

Main advantages

- Quick connection and disconnection
- Full Flow and Vacuum resistant tank to special shaped seals
- 3 threads available, BSPP, BSPT (universal short) & Metric
- Lighter and More compact
- Specific configurations to satisfy the advanced robotics
- Silicon Free

Applications

- Robotics
- Automotive
- Textile, Packaging, Handling
- Compressed Air Circuit
- Industrial Water
- Vacuum

Die 55.000 - 56.000er-Serie wurde als Antwort auf die extremsten Anforderungen in der pneumatischen Automation entwickelt. Diese Serie ist aus Technopolymer, leichter und kompakter, welche anspruchsvollen Kunden hohe Leistungsfähigkeit bietet.

Liefersortiment \varnothing 2 - 14 mm.

Hauptvorteile

- Schnelle Verbindung und Trennung
- Voller Durchfluss und Vakuumfestigkeit, dank spezieller Formdichtungen
- Drei Gewindearten, BSPP, BSPT (universal kurz) und metrisch
- Leichter und kompakter
- Spezielle Konfigurationen, um der fortschrittlichen Robotertechnik gerecht zu werden
- Silikonfrei

Anwendungen

- Robotik
- Automobil-Industrie
- Textil-, Verpackungs-, Handlingindustrie
- Druckluftkreislauf
- Industrielle Wasser
- Vakuum

La série 55000 - 56000 répond aux principales attentes dans les applications des automatismes pneumatiques. Cette gamme en technopolymère, plus légère et plus compacte offre aux clients exigeants des performances élevées.

Large gamme \varnothing 2 - 14 mm.

Principaux avantages

- Connexion et déconnexion rapides
- Plein débit et tenue au vide grâce à des joints de forme
- 3 filetages disponibles, BSPP, BSPT (universal court) et métrique
- Légèreté et compacité
- Configurations spécifiques pour répondre à la robotique de pointe
- Sans silicone

Applications

- Robotique
- Automobile
- Textile, Conditionnement, Manutention
- Circuit Air comprimé
- Eau industrielle
- Vide industriel

La Serie 55.000 - 56.000 llegó para satisfacer las más extremas demandas de la automatización neumática. Es una línea en tecnopolímero, ligera y más compacta que ofrece a los clientes altas prestaciones.

Amplia gama de \varnothing 2 - 14 mm.

Principales ventajas

- Conexión y desconexión instantánea
- Paso total y estanqueidad al vacío gracias a las juntas moldeadas
- Tres tipos de roscas, BSPP, BSPT (universal short) y métricas
- Ligero y más compacto
- Configuraciones específicas para satisfacer la robótica avanzada
- Libre de silicona

Aplicaciones

- Automatización Neumática
- Automoción
- Industria textil, envasado, manipulación
- Circuitos de aire comprimido
- Agua Industrial
- Vacío

A série 55.000 - 56000 veio para atender as mais extremas demandas de aplicações da automação pneumática. É uma linha em tecnopolímero, mais leve e mais compacta que oferece aos clientes performances mais altas.

Grande range de itens : \varnothing 2 - 14 mm.

Principais vantagens

- Rápida conexão e desconexão
- Vazão total e resistência ao vácuo graças ao design de suas vedações
- 3 tipos de rosca disponíveis: BSPP, BSPT (universal short) & Métrica.
- Leveza e compacidade
- Configurações específicas para atender robótica avançada
- Livre de Silicone

Aplicações

- Robótica
- Automotiva
- Têxtil, Embalagem, Manipulação
- Circuitos de Ar Comprimido
- Água Industrial
- Vácuo



CARATTERISTICHE TECNICHE
 TECHNICAL CHARACTERISTICS
 TECHNISCHE ANGABEN
 CARACTÉRISTIQUES TECHNIQUES
 CARACTERÍSTICAS TÉCNICAS
 CARACTERÍSTICAS TÉCNICAS



Norma di Riferimento
 Reference standard
 Entspricht der Norm
 Norme de référence
 Normativa de referencia
 Norma de referência

1907/2006

REACH

2011/65/CE

RoHS

PED

2014/68/UE

ISO
14743:2004

SILICON
FREE

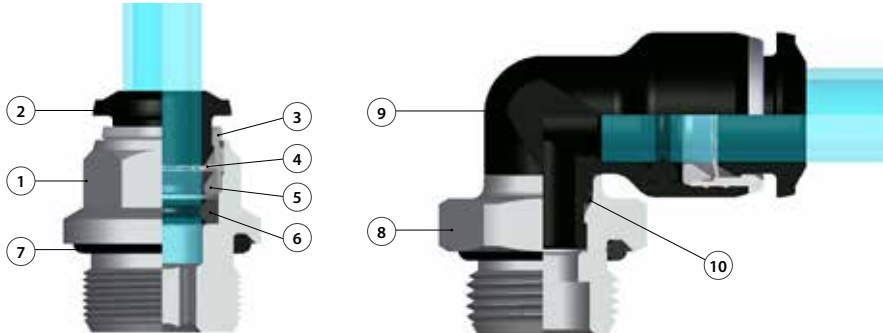

Materiali e Componenti

IT

- 1 Corpo in ottone nichelato
- 2 Spintore sgancio tubo resina acetica
- 3 Capsula in ottone nichelato
- 4 Pinza d'aggraffaggio in acciaio inox AISI 301
- 5 Anello di posizionamento in tecnopolimero
- 6 Guarnizione sagomata in NBR
- 7 Guarnizione filetto in NBR
- 8 Basetta Filettata in Ottone Nichelato
- 9 Corpo in tecnopolimero PA
- 10 Guarnizione in NBR

Component Parts and Materials

GB

- 1 Nickel-plated brass Body
- 2 Acetalic resin Collet
- 3 Nickel-plated brass Capsule
- 4 Steel AISI 301 Clamping washer
- 5 Technopolymeric positioning ring
- 6 NBR Molded seal
- 7 NBR Thread packing
- 8 Base Threaded Nickel Plated Brass
- 9 Technopolymeric Body PA
- 10 NBR seal

Komponenten und Materialien

DE

- 1 Körper Messing vernickelt
- 2 Rohr Lösering Acetal
- 3 Haltering Messing vernickelt
- 4 Zahnscheibe Edelstahl AISI 301
- 5 Positionierring Technopolymer
- 6 Lippendichtung NBR
- 7 Gewindeabdichtung NBR
- 8 Gewindebasis Messing vernickelt
- 9 Körper Technopolymer PA
- 10 Lippendichtung NBR

Matériaux et Composants

FR

- 1 Corps: Laiton nickelé
- 2 Pousoir: Résine acétal
- 3 Capsule de retenue: Laiton nickelé
- 4 Rondelle d'accrochage: AISI 301
- 5 Anneau de positionnement: Technopolymère
- 6 Joint à lèvres: NBR
- 7 Joint d'étanchéité du filetage: NBR
- 8 Bague de sécurité en laiton nickelé
- 9 Corps: Technopolymère PA
- 10 Joint en NBR

Materiales y Componentes

ES

- 1 Cuerpo en latón niquelado
- 2 Anillo de extracción tubo en resina acetalica
- 3 Cápsula en latón niquelado
- 4 Pinza de agarre en acero inox AISI 301
- 5 Anillo de posicionamiento en tecnopolimero
- 6 Junta de forma en NBR
- 7 Junta rosca en NBR
- 8 Base roscada en latón niquelado
- 9 Cuerpo en tecnopolimero PA
- 10 Junta en NBR

Materiais e Componentes

PT

- 1 Corpo em latão niquelado
- 2 Anilha de liberação do tubo em resina acetálica
- 3 Cápsula de latão niquelado
- 4 Pinça de travamento em aço-inox AISI 301
- 5 Anel de posicionamento em tecnopolímero
- 6 Vedação em NBR
- 7 Vedação da rosca em NBR
- 8 Base roscada em latão niquelado
- 9 Corpo em tecnopolímero PA
- 10 Vedação em NBR



Pressioni

Pressures
 Druckbereich
 Pressions
 Presiones
 Pressões

- 0.99 bar (-0.099 MPa)
 20 bar (2.0 MPa)



Temperature

Temperatures
 Temperatur
 Températures
 Temperaturas
 Temperaturas

- 20 °C
 + 80 °C



Fluidi compatibili

Aria compressa / Vuoto / Acqua

Fluids
 Compressed air / Vacuum / Water

Geeignete Medien
 Druckluft / Vakuum / Wasser

Fluides compatibles
 Air comprimé / Vide / Eau

Fluidos compatibles
 Aire comprimido / Vacío / Agua

Fluidos compatíveis
 Ar comprimido / Vácuo / Água



Tubi di Collegamento

IT

Tubi in materiale plastico:
 PA6, PA11, PA12, Polietilene, *Poliuretano, PTFE, FEP.
 *Per tubi in Poliuretano è consigliata una durezza di 98 shore.

Connection Tubes

GB

Plastic tubes:
 PA6, PA11, PA12, Polyethylene, *Polyurethane, PTFE, FEP.
 *For Polyurethane hoses it is required a minimum hardness of 98 shore.

Geeignete Rohre

DE

Kunststoffrohre:
 PA6, PA11, PA 12, Polyethylene, *Polyurethan, PTFE, FEP.
 *Für Polyurethan Rohre ist eine Härte von 98 Shore empfohlen.

Tubes Conseillés

FR

Tubes plastiques:
 PA6, PA11, PA12, Polyéthylène, *Polyuréthane, PTFE, FEP.
 *Pour les tubes en polyuréthane, il est conseillé une dureté de 98 Shore.

Tubos de Conexión

ES

Tubos en material plástico:
 PA6, PA11, PA 12, Polietileno, *Poliuretano, PTFE, FEP.
 *Para tubos en poliuretano es aconsejada una dureza de 98 shore.

Tubos de Conexão

PT

Tubos em material plástico:
 PA6, PA11, PA12, Polietileno, *Poliuretano, PTFE, FEP.
 *Para tubos em Poliuretano é requerida uma dureza de 98 shore.



<p>Filettatura IT</p> <p>Gas conica "UNIVERSAL SHORT". Gas conica conforme ISO 7.1, BS 21, DIN 2999. Gas cilindrica conforme ISO 228 Classe A. Metrica conforme ISO R/262.</p>	<p>Threads GB</p> <p>"UNIVERSAL SHORT" Tapered thread. Tapered gas in conformity with ISO 7.1, BS 21, DIN 2999. Parallel gas in conformity with ISO 228 Class A. Metric in conformity with ISO R/262.</p>	<p>Gewindearten DE</p> <p>Konisches Gewinde "UNIVERSAL SHORT". Konisches Gewinde nach Norm ISO 7.1, BS 21, DIN 2999. Zylindrisches Gewinde nach Norm ISO 228 Classe A. Metrisches Gewinde nach Norm ISO R/262.</p>
<p>Filetages FR</p> <p>Filetage conique "UNIVERSAL SHORT". Filetage conique conforme: ISO 7.1, BS 21, DIN 2999. Filetage cylindrique conforme: ISO 228 Classe A. Filetage métrique conforme: ISO R/262.</p>	<p>Roscas ES</p> <p>Gas cónica "UNIVERSAL SHORT". Gas cónica conforme ISO 7.1, BS 21, DIN 2999. Gas cilíndrica conforme ISO 228 Clase A. Métrica conforme ISO R/262.</p>	<p>Roscas PT</p> <p>Gas cónica "UNIVERSAL SHORT". Gas cónica conforme ISO 7.1, BS 21, DIN 2999. Gas paralela conforme ISO 228 Classe A. Métrica conforme ISO R/262.</p>



UNIVERSAL SHORT

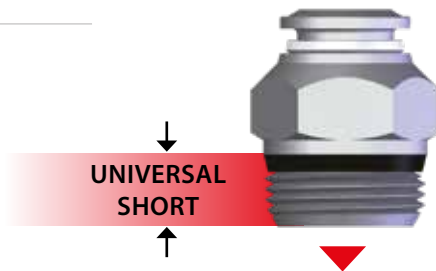

<p>NPT NPTF</p> <p>Conica Tapered Konisch Conique Cónica Cônica</p>	<p>ISO 7 BSPP</p> <p>Cilíndrica Paralell Zylindrisch Cylindrique Cilíndrica Paralela</p>	<p>ISO 7 BSPT PT</p> <p>Conica Tapered Konisch Conique Cónica Cônica</p>	<p>ISO 228 BSP PF</p> <p>Cilíndrica Paralell Zylindrisch Cylindrique Cilíndrica Paralela</p>
---	--	---	---

<p>"UNIVERSAL SHORT" IT</p> <p>La filettatura conica "UNIVERSAL SHORT" è progettata per soddisfare le seguenti caratteristiche:</p> <ul style="list-style-type: none"> • ridurre la lunghezza d'ingombro; • ridurre la chiave rispetto ad alcuni raccordi con filettature cilindriche; • consentire l'accoppiamento con diversi standard di filettature femmina sia coniche che cilindriche. 	<p>"UNIVERSAL SHORT" GB</p> <p>The "UNIVERSAL SHORT" taper thread has been designed to offer the following advantages to the users:</p> <ul style="list-style-type: none"> • reduced overall length; • smaller hex dimensions compared to the parallel threads; • to allow the assembly with different female threads both taper as well as parallel. 	<p>"UNIVERSAL SHORT" DE</p> <p>Das konische Gewinde "UNIVERSAL SHORT" ist so konzipiert, dass folgende Vorteile erzielt werden:</p> <ul style="list-style-type: none"> • Reduzierung der Länge des Gewindes - kürzere Montagezeit; • Reduzierung der Schlüsselweite im Vergleich von Verschraubungen mit zylindrischen Gewinden geringerer Lochabstand; • Ermöglicht den Einsatz in verschiedene Gewindearten, sowie in konische- und zylindrische Innengewinde.
---	--	---

<p>"UNIVERSAL SHORT" FR</p> <p>Le filetage conique "UNIVERSAL SHORT" a été conçu pour satisfaire les exigences suivantes:</p> <ul style="list-style-type: none"> • réduire la longueur d'encombrement; • réduire les dimensions hexagonales par rapport au filetage cylindrique; • permettre le montage avec divers taraudages standards soit coniques soit cylindriques. 	<p>"UNIVERSAL SHORT" ES</p> <p>La rosca cónica "UNIVERSAL SHORT" ha sido proyectada para satisfacer las siguientes características:</p> <ul style="list-style-type: none"> • reducir la longitud; • reducir la llave respecto a algunos racores con rosca cilíndrica; • consentir el acoplamiento con diferentes standard de rosas hembra sean cónicas o cilíndricas. 	<p>"UNIVERSAL SHORT" PT</p> <p>A rosca cónica "UNIVERSAL SHORT" é projetada para satisfazer às seguintes características:</p> <ul style="list-style-type: none"> • reduzir o comprimento da conexão; • reduzir o dimensional com relação às rosas paralelas; • permitir o acoplamento da conexão a diferentes tipos de rosca fêmea, sejam elas cónicas ou paralelas.
--	--	---



<p>IT</p> <p>Consentire una completa tenuta anche su superfici non perfettamente piane, concave, convesse o inclinate, con diversi smussi o raggi.</p>	<p>GB</p> <p>To ensure the right tightening also with surfaces not perfectly flat, without spot-facing, concave convex and with different kinds of chamfers or radius.</p>	<p>DE</p> <p>Eine vollständige Abdichtung ist auch auf unebenen Flächen, wie geneigt, konkav oder konvex und mit unterschiedlichen Radien oder Fasen gewährleistet.</p>
<p>FR</p> <p>Pour permettre une parfaite étanchéité même sur des surfaces non planes, concaves, convexas ou inclinées et avec différents chanfreins ou rayons.</p>	<p>ES</p> <p>Consentir una completa estanqueidad incluso en superficies no perfectamente planas, cóncavas, convexas o inclinadas, con diferentes ángulos o radios.</p>	<p>PT</p> <p>Permite um aperto correto em superfícies não perfeitamente planas, côncavas, convexas ou inclinadas, com diferentes chanfros ou raios.</p>



Coppia di serraggio

Torque specifications

Angaben Drehmoment

Couple de serrage

Par de apriete

Especificações de Torque



ISO 228



"UNIVERSAL SHORT"

I valori di rottura possono variare in base all'articolo
 Breaking values may vary according to the item
 Die maximal werte dienen nur zu informationszwecken
 Les valeurs maximales sont présentées à titre indicatif
 Los valores de rotura pueden variar en función del artículo
 Os valores de ruptura podem variar em função do item

MISURA MEASURE GRÖSSE DIMENSIONS MEDIDA MEDIDA	COPPIA CONSIGLIATA Nm RECOMMENDED TORQUE Nm EMPFOHLENES DREHMOMENT Nm COUPLE DE SERRAGE Nm PAR ACONSEJADO Nm TORQUE RECOMENDADO Nm	COPPIA DI ROTTURA Nm BREAKING TORQUE Nm ABSCHERDREHMOMENT Nm COUPLE DE RUPTURE Nm PAR DE ROTURA Nm TORQUE DE RUPTURA Nm
M5	0,8	3,2
M7	3	8
M8	3	8
1/8	3	8
1/4	9	30
3/8	10	60
1/2	12	50

MISURA MEASURE GRÖSSE DIMENSIONS MEDIDA MEDIDA	COPPIA MINIMA CONSIGLIATA Nm RECOMMENDED MINIMUM TORQUE Nm EMPFOHLENES DREHMOMENT Nm COUPLE DE SERRAGE Nm PAR MÍNIMO ACONSEJADO Nm TORQUE MÍNIMO RECOMENDADO Nm	COPPIA MASSIMA CONSIGLIATA Nm RECOMMENDED MAX TORQUE Nm ABSCHERDREHMOMENT Nm COUPLE DE RUPTURE Nm PAR MÁXIMO ACONSEJADO Nm TORQUE MÁXIMA RECOMENDADO Nm
1/8	5	7
1/4	5	7
3/8	5	7
1/2	5	7

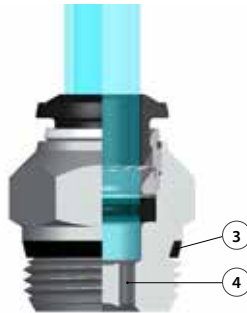
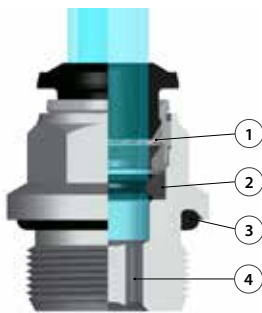

Vantaggi

IT

- 1 La pinza in acciaio inox garantisce il perfetto aggraffaggio di tubi di qualsiasi materiale senza danneggiarne la superficie. Il collegamento tra tubo e raccordo assicura una tenuta totale anche in condizioni di urti e vibrazioni.
- 2 La particolare geometria della guarnizione permette inoltre l'utilizzo dei raccordi anche con il vuoto.
- 3 Tutte le filettature di questa serie sono state dotate di elementi di tenuta che permettono l'immediato utilizzo dei raccordi riducendo notevolmente i tempi di installazione.
- 4 Tutti i raccordi diritti possono essere montati anche con chiave esagonale ed è possibile utilizzarli anche in spazi molto ridotti.

Advantages

GB

- 1 The washer is made in stainless steel ensures the perfect tube clamping with every kinds of materials without damage the surface. The connection between the tube and the fitting ensure a total tightness even in severe conditions such as impact and vibrations.
- 2 The particular geometric shape of the seal ensure the perfect tightness even with vacuum.
- 3 All of threads from this range have been equipped with tightening parts which allow the direct assembly of the fittings, reducing the installation time.
- 4 All the straight fittings can be assembled also with Allen wrench and it is possible to use them in reduced spaces.

Vorteile

DE

- 1 Konisches Gewinde "kurz" Die Zahnscheibe sorgt für eine perfekte Halterung des Rohres ohne die Oberfläche zu beschädigen. Die Dichtheit zwischen Rohr und Verschraubung ist auch bei Erschütterungen und Vibrationen gewährleistet.
- 2 Die besondere Geometrie der Dichtung ermöglicht auch die Anwendung der Verschraubungen in Verbindung mit Vakuum.
- 3 Alle Verschraubungen in dieser Serie sind mit Gewindeabdichtungen ausgestattet, die den sofortigen Einsatz ermöglichen und daher die Montagezeit stark reduzieren.
- 4 Alle geraden Verschraubungen können auch mit Inbussschlüsseln montiert werden, daher kleiner Lochabstand möglich.

Avantages

FR

- 1 La rondelle en acier inoxydable garantit la parfaite tenue du tube quelle que soit la matière et sans l'endommager. La connexion entre le tube et le raccord assure une étanchéité totale même dans des conditions d'impact ou de vibrations.
- 2 La spécificité géométrique du joint permet l'utilisation des raccords avec le vide.
- 3 Tous les filetages de cette série sont équipés d'éléments d'étanchéité qui permettent l'utilisation immédiate des raccords réduisant ainsi le temps d'installation.
- 4 Tous les raccords droits peuvent être aussi montés avec une clé hexagonale pour permettre une utilisation dans des espaces réduits.

Ventajas

ES

- 1 La pinza en acero inoxidable garantiza el perfecto agarre del tubo de cualquier material sin perjudicar la superficie. La conexión entre tubo y racor asegura una estanqueidad total aun en condiciones de impacto o vibración.
- 2 La particular geometría de la junta garantiza una perfecta estanqueidad incluso en vacío.
- 3 Todas las rosas de esta serie están fabricadas con junta de cierre que permite la inmediata utilización del racor reduciendo notablemente el tiempo de instalación.
- 4 Todos los racores rectos pueden montarse también con llave hexagonal y es posible utilizarlos incluso en espacios muy reducidos.

Vantagens

PT

- 1 A pinça em aço-inox garante o perfeito travamento do tubo de qualquer material sem danificar a superfície do mesmo. A conexão entre o tubo e a conexão assegura uma vedação total também em condições de impactos e vibrações.
- 2 A geometria particular da vedação permite a utilização da conexão também para aplicações com vácuo.
- 3 Todas as rosas desta série são dotadas de elementos de vedação, o que permite a imediata utilização das conexões, reduzindo notavelmente o tempo de instalação.
- 4 Todas as conexões retas podem ser montadas também com chave allen tornando possível montagem das mesmas em espaços bem reduzidos.

55000

New

RACCORDO DIRITTO MASCHIO "UNIVERSAL SHORT"

STRAIGHT MALE ADAPTOR "UNIVERSAL SHORT"
 GERADE EINSCHRAUBVERSCHRAUBUNG KONISCH "UNIVERSAL SHORT"
 RACCORD DROIT MÂLE, CONIQUE "UNIVERSAL SHORT"
 RACOR RECTO MACHO CÔNICO "UNIVERSAL SHORT"
 CONEXÃO RETA COM ROSCA "UNIVERSAL SHORT"

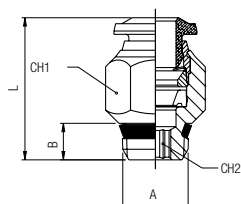

Code	Tube	A	B	L	CH1	CH2	Pack.
55000 00 001	4	1/8	5.5	18	11	3	10
55000 00 013	4	1/4	7	19	14	3	10
55000 00 002	5	1/8	5.5	20	11	4	10
55000 00 003	5	1/4	7	20	14	4	10
55000 00 004	6	1/8	5.5	21.5	13	4	10
55000 00 005	6	1/4	7	21	14	4	10
55000 00 014	6	3/8	7.5	23	17	4	10
55000 00 015	6	1/2	9	23.5	21	4	10
55000 00 006	8	1/8	5.5	24.5	14	5	10
55000 00 007	8	1/4	7	22	14	6	10
55000 00 008	8	3/8	7.5	23	17	6	10
55000 00 016	8	1/2	9	23.5	21	6	10
55000 00 009	10	1/4	7	28	17	7	10
55000 00 010	10	3/8	7.5	25.5	17	8	10
55000 00 017	10	1/2	9	26	21	8	10
55000 00 011	12	1/4	7	31.5	20	7	10
55000 00 012	12	3/8	7.5	29.5	20	9	10
55000 00 018	12	1/2	9	31.5	21	10	10
55000 00 019	14	3/8	7.5	32.5	21	9	10
55000 00 020	14	1/2	9	31.5	21	10	10
55000 00 021	16	3/8	7.5	34.8	23	10	10
55000 00 022	16	1/2	9	35.8	25	12	10

55010

RACCORDO DIRITTO MASCHIO ESAGONO INCASSATO

STRAIGHT MALE ADAPTOR WITH EXAGON EMBEDDED
 GERADE EINSCHRAUBVERSCHRAUBUNG MIT INNENSECHSKANT
 RACCORD DROIT MÂLE, CONIQUE, 6-PANS INTERIEUR
 RACOR RECTO MACHO CÔNICO HEXÁGONO INTERIOR
 CONEXÃO RETA COM SEXTAVADO INTERNO E ROSCA

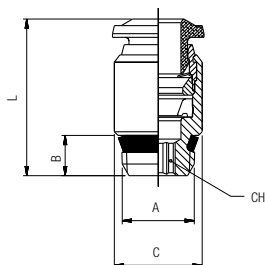

Code	Tube	A	B	C	L	CH	Pack.
55010 00 001	4	1/8	5.5	11	18	3	10
55010 00 002	6	1/8	5.5	12	21.5	4	10
55010 00 003	6	1/4	7	14	21	4	10
55010 00 004	8	1/8	5.5	14	25	5	10
55010 00 005	8	1/4	7	14	22.5	6	10

50010N

RACCORDO DIRITTO MASCHIO CILINDRICO ESAGONO INCASSATO

STRAIGHT MALE ADAPTOR (PARALLEL) WITH EXAGON EMBEDDED
 GERADE EINSCHRAUBVERSCHRAUBUNG MIT INNENSECHSKANT ZYLINDRISCH
 RACCORD DROIT MÂLE, CYLINDRIQUE, 6-PANS INTERIEUR
 RACOR RECTO MACHO CILÍNDRICO CON TÓRICA HEXÁGONO INTERIOR
 CONEXÃO RETA COM SEXTAVADO INTERNO E ROSCA MÉTRICA

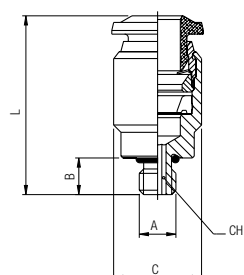

Code	Tube	A	B	C	L	CH	Pack.
50010 00 N08	3	M5	3.6	8	19	2.5	10
50010 00 N01	4	M5	3.6	10	21	2.5	10
50010 00 N09	4	M7x1	4.8	10	21	2.5	10
50010 00 N07	6	M5	3.6	12	23.5	2.5	10
50010 00 N11	6	M6x1	3.6	12.5	24	2.5	10

50020N

New
RACCORDO DIRITTO MASCHIO CILINDRICO

STRAIGHT MALE ADAPTOR (PARALLEL)

GERADE EINSCHRAUBVERSCHRAUBUNG ZYLINDRISCH

RACCORD DROIT MÂLE, CYLINDRIQUE

RACOR RECTO MACHO CILÍNDRICO CON TÓRICA

CONEXÃO RETA COM ROSCA PARALELA

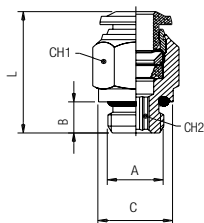

Code	Tube	A	B	C	L	CH1	CH2	Pack.
50020 00 N21	3	M5	3.6	8	19	8	2	10
50020 00 N34	4	M3	3	10	21	8	-	10
50020 00 N01	4	M5	3.6	8	21	10	2	10
50020 00 N02	4	1/8	5.4	13	20	10	3	10
50020 00 N22	4	1/4	7.1	16	19.5	16	3	10
50020 00 N41	4	3/8	8.1	20	18	20	3	10
50020 00 N18	5	M5	3.6	8	23.5	12	2	10
50020 00 N19	5	1/8	5.4	13	22	12	4	10
50020 00 N36	5	1/4	7.1	16	22	12	4	10
50020 00 N20	6	M5	3.6	10	24.5	13	2	10
50020 00 N03	6	1/8	5.4	13	23.5	13	4	10
50020 00 N04	6	1/4	7.1	16	23.5	13	4	10
50020 00 N27	6	3/8	8.1	20	25	13	4	10
50020 00 N28	6	1/2	9.6	25	27	13	4	10
50020 00 N05	8	1/8	5.4	13	25	14	5	10
50020 00 N06	8	1/4	7.1	16	23	14	6	10
50020 00 N07	8	3/8	8.1	20	24	14	6	10
50020 00 N29	8	1/2	9.6	25	26.5	14	6	10
50020 00 N08	10	1/4	7.1	16	30.5	17	6	10
50020 00 N09	10	3/8	8.1	20	27.5	17	8	10
50020 00 N31	10	1/2	9.6	25	27	17	8	10
50020 00 N32	12	1/4	7.1	16	34.5	20	6	10
50020 00 N11	12	3/8	8.1	20	34	20	8	10
50020 00 N23	12	1/2	9.6	25	31	22	10	10
50020 00 N24	14	3/8	8.1	20	35	21	10	10
50020 00 N25	14	1/2	9.6	25	32	22	11	10
50020 00 N42	16	3/8	8.1	20	35.8	23	10	10
50020 00 N43	16	1/2	9.6	25	36.8	25	12	10
50020 00 N46	4	M6x1	5.4	12	18.5	10	3	10
50020 00 N33	4	M8x1	5.4	12	18.5	10	3	10
50020 00 N37	6	M8x1	5.4	12	24.5	13	3	10
50020 00 N38	6	M10x1	5.4	13	23	13	4	10
50020 00 N12	6	M12x1	7.3	15	23.5	13	4	10
50020 00 N13	6	M12x1.25	7.3	15	23.5	13	4	10
50020 00 N14	6	M12x1.5	7.3	15	23.5	13	4	10
50020 00 N39	8	M8x1	5.4	12	25.5	14	4	10
50020 00 N40	8	M10x1	5.4	13	25.5	14	4	10
50020 00 N17	8	M12x1.5	7.3	15	27.5	14	6	10

50030N

New
RACCORDO DIRITTO FEMMINA

STRAIGHT FEMALE ADAPTOR

AUFSCHRAUBVERSCHRAUBUNG

RACCORD DROIT, TARAUDE

RACOR RECTO HEMBRA

CONEXÃO RETA COM ROSCA FÊMEA

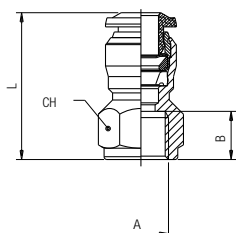

Code	Tube	A	B	L	CH	Pack.
50030 00 N08	4	M5	5.5	21	11	10
50030 00 N01	4	1/8	8.5	24	13	10
50030 00 N09	4	1/4	11	27.5	16	10
50030 00 N06	5	1/8	8.5	26.5	13	10
50030 00 N02	6	1/8	8.5	26	13	10
50030 00 N03	6	1/4	11	29.5	16	10
50030 00 N04	8	1/8	8.5	27	15	10
50030 00 N05	8	1/4	11	29.5	17	10
50030 00 N10	8	3/8	12	32	19	10
50030 00 N11	10	1/4	11	32	18	10
50030 00 N12	10	3/8	12	33.5	19	10
50030 00 N13	10	1/2	15	39	24	10
50030 00 N14	12	3/8	12	36	21	10
50030 00 N15	12	1/2	15	41	24	10
50030 00 N16	16	3/8	12	40.3	24	10
50030 00 N17	16	1/2	15	41.3	24	10

55040

New

RACCORDO DIRITTO INTERMEDIO

STRAIGHT CONNECTOR
 VERBINDUNGSVERSCHRÄUBUNG
 RACCORD UNION DOUBLE
 RACOR RECTO INTERMEDIO
 CONEXÃO RETA TUBO-TUBO

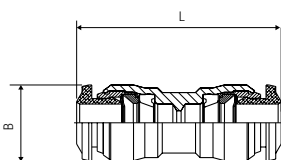

Code	Tube	Tube	L	B	Pack.
55040 00 002	4	4	31	10	10
55040 00 003	5	5	34	12	10
55040 00 004	6	6	35	12,5	10
55040 00 009	6	4	34	12,5	10
55040 00 005	8	8	37	14	10
55040 00 015	8	4	37	14	10
55040 00 010	8	6	37	14	10
55040 00 006	10	10	45	17	10
55040 00 014	10	6	44	17	10
55040 00 011	10	8	44	17	10
55040 00 007	12	12	50	20	10
55040 00 016	12	8	50	20	10
55040 00 012	12	10	50	20	10
55040 00 008	14	14	48	21	10
55040 00 017	14	12	48	21	10
55040 00 018	16	16	53.6	24	10

50050N

RACCORDO DIRITTO INTERMEDIO DI ATTRAVERSAMENTO

BULKHEAD CONNECTOR
 SCHOTTVERSCHRÄUBUNG
 TRAVERSÉE DE CLOISON
 RACOR RECTO INTERMEDIO PASATABIQUES
 CONEXÃO PASSA-MURO RETA TUBO-TUBO

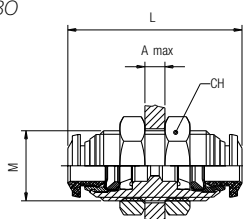

Code	Tube	M	L	CH	A max	Pack.
50050 00 N07	3	M10x1	26	14	5	10
50050 00 N01	4	M12x1	31.5	17	7	10
50050 00 N06	5	M14x1	33	17	7	10
50050 00 N02	6	M14x1	35	17	9.5	10
50050 00 N09	8-6	M16x1	37	19	10.5	10
50050 00 N03	8	M16x1	37	19	10.5	10
50050 00 N10	10-6	M20x1	43	24	11.5	10
50050 00 N11	10-8	M20x1	42.5	24	12.5	10
50050 00 N04	10	M20x1	43	24	12.5	10
50050 00 N05	12	M22x1	48	26	16.5	10
50050 00 N08	14	M23x1	49	27	16.5	10

55050

RACCORDO DIRITTO INTERMEDIO DI ATTRAVERSAMENTO

BULKHEAD CONNECTOR
 SCHOTTVERSCHRÄUBUNG
 TRAVERSÉE DE CLOISON
 RACOR RECTO INTERMEDIO PASATABIQUES
 CONEXÃO PASSA-MURO RETA TUBO-TUBO

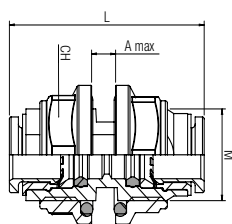

Code	Tube	M	L	CH	A max	Pack.
55050 00 005	8	M16x1	38.8	18	14.5	10

50055N

RACCORDO DIRITTO DI ATTRAVERSAMENTO FEMMINA

FEMALE BULKHEAD CONNECTOR
 SCHOTTVERSCHRÄUBUNG INNENGEWINDE
 TRAVERSÉE DE CLOISON FEMELLE
 RACOR RECTO INTERMEDIO PASATABIQUES HEMBRA
 CONEXÃO PASSA-MURO RETA FEMEA

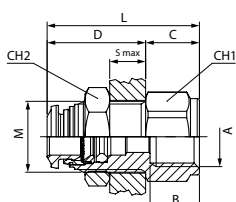

Code	Tube	A	B	M	S max	CH1	CH2	C	D	L	Pack.
50055 00 N01	4	1/8	8.5	M12X1	7	15	17	10	19	29	10
50055 00 N02	6	1/8	8.5	M14X1	8	16	17	10	21	31	10
50055 00 N03	6	1/4	11	M14X1	8	16	17	12	21	33	10
50055 00 N04	8	1/8	8.5	M16X1	8	18	19	10	22	32	10
50055 00 N05	8	1/4	11	M16X1	8	18	19	12	22	34	10
50055 00 N06	10	3/8	12	M20X1	9.5	24	24	14	25.5	39.5	10
50055 00 N07	12	3/8	12	M22X1	10.5	24	26	15	27.5	42.5	10
50055 00 N08	12	1/2	15	M22X1	10.5	24	26	17	27.5	44.5	10

50465N

ADATTATORE DIRITTO INTERMEDIO DI ATTRAVERSAMENTO

BULKHEAD CONNECTOR
SCHOTTVERSCHRAUBUNG
ADAPTEUR DROIT TRAVERSEE DE CLOISON
RACOR RECTO INTERMEDIO PASATABIQUES
CONEXÃO PASSA-MURO RETA TUBO-TUBO

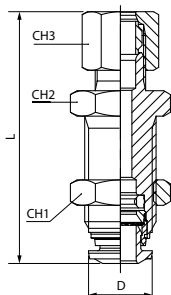

Code	Tube	L	D	CH1	CH2	CH3	Pack.
50465 00 N02	6	49.5	12.5	13	17	17	10
50465 00 N03	8	52	14	14	19	19	10
50465 00 N04	10	59	17	19	24	24	10

55060

RACCORDO A L ORIENTABILE INTERMEDIO DI ATTRAVERSAMENTO

BULKHEAD ORIENTING ELBOW
WINKEL-SCHOTTVERSCHRAUBUNG (DREHBAR)
RACCORD EQUERRE ORIENTABLE A TRAVERSÉE DE CLOISON
RACOR A L ORIENTABLE INTERMEDIO PASATABIQUES
CONEXÃO PASSA-MURO EM "L" ORIENTÁVEL

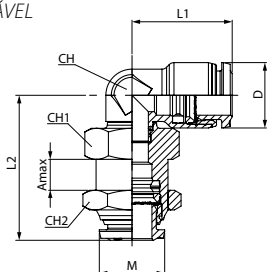

Code	Tube	M	L1	L2	CH	CH1	CH2	Amax	D	Pack.
55060 00 003	4	M12x1	16.5	30	7	14	17	6.5	10	10
55060 00 004	6	M14x1	20.5	31	9	16	17	6.5	12	10
55060 00 005	8	M16x1	22.5	34	10	18	19	7	14	10
55060 00 006	10	M20x1	26.5	39	13	18	24	7.5	17	10
55060 00 007	12	M22x1	30	44	16	25	26	9.5	20	10

55106

RACCORDO A L ORIENTABILE FEMMINA

ORIENTING ELBOW FEMALE ADAPTOR
AUFSCRAUB WINKELSCHRAUBUNG (DREHBAR)
EQUERRE ORIENTABLE FEMALE
RACOR A L ORIENTABLE HEMBRA
CONEXÃO EM "L" ORIENTÁVEL COM ROSCA FÊMEA

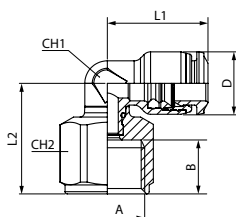

Code	Tube	A	B	L1	L2	CH1	CH2	D	Pack.
55106 00 001	4	1/8	8.5	16.5	19	7	13	10	10
55106 00 002	4	1/4	11	16.5	22.5	7	16	10	10
55106 00 003	6	1/8	8.5	20.5	20	9	13	12.5	10
55106 00 004	6	1/4	11	20.5	23.5	9	16	12.5	10
55106 00 005	8	1/8	8.5	22.5	21	10	13	14	10
55106 00 006	8	1/4	11	22.5	23.5	10	16	14	10
55106 00 007	8	3/8	12	22.5	24.5	10	19	14	10
55106 00 008	10	1/4	11	26.5	27	13	16	17	10
55106 00 009	10	3/8	12	26.5	27	13	19	17	10

55111

New

RACCORDO A L ORIENTABILE MASCHIO "UNIVERSAL SHORT"

ORIENTING ELBOW MALE ADAPTOR "UNIVERSAL SHORT"
WINKELVERSCHRAUBUNG KONISCH (DREHBAR) "UNIVERSAL SHORT"
EQUERRE ORIENTABLE MÂLE, CONIQUE "UNIVERSAL SHORT"
RACOR A L ORIENTABLE MACHO CÔNICO "UNIVERSAL SHORT"
CONEXÃO MACHO EM "L" ORIENTÁVEL COM ROSCA "UNIVERSAL SHORT"

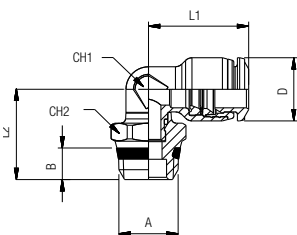

Code	Tube	A	B	L1	L2	CH1	CH2	D	Pack.
55111 00 001	4	1/8	5.5	16.5	16.5	7	13	10	10
55111 00 002	4	1/4	7	16.5	18	7	15	10	10
55111 00 003	5	1/8	5.5	20	17.5	9	13	12	10
55111 00 004	6	1/8	5.5	20.5	17.5	9	13	12	10
55111 00 005	6	1/4	7	20.5	18.9	9	15	12	10
55111 00 006	6	3/8	7.5	20.5	20	9	17	12	10
55111 00 007	6	1/2	9	20.5	22	9	21	12	10
55111 00 008	8	1/8	5.5	22	18.5	10	13	14	10
55111 00 009	8	1/4	7	22	20	10	15	14	10
55111 00 010	8	3/8	7.5	22	20.5	10	17	14	10
55111 00 011	8	1/2	9	22	23	10	21	14	10
55111 00 012	10	1/4	7	26.5	21.8	13	16	17	10
55111 00 013	10	3/8	7.5	26.5	21.8	13	17	17	10
55111 00 014	10	1/2	9	26.5	24.3	13	21	17	10
55111 00 015	12	1/4	7	30	23.1	16	16	20	10
55111 00 016	12	3/8	7.5	30	23.1	16	17	20	10
55111 00 017	12	1/2	9	30	25.6	16	21	20	10
55111 00 018	14	3/8	7.5	31	26.5	18	20	21	10
55111 00 019	14	1/2	9	31	27	18	21	21	10
55111 00 020	16	3/8	7.5	32.8	33.8	20	22	24	10
55111 00 021	16	1/2	9	32.8	34.8	20	22	24	10

55116

New

RACCORDO A L ORIENTABILE MASCHIO CILINDRICO

ORIENTING ELBOW MALE ADAPTOR (PARALLEL)

WINKELVERSCHRAUBUNG ZYLINDRISCH (DREHBAR)

EQUERRE ORIENTABLE MÂLE, CYLINDRIQUE

RACOR A L ORIENTABLE MACHO CILÍNDRICO CON TÓRICA

CONEXÃO MACHO EM "L" ORIENTÁVEL COM ROSCA PARALELA

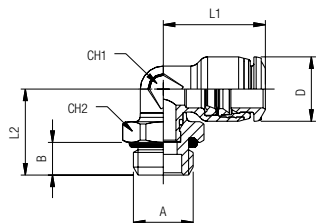

Code	Tube	A	B	L1	L2	CH1	CH2	D	Pack.
55116 00 001	4	M3x0.5	3	16.5	12	7	9	10	10
55116 00 002	4	M5	3.6	16.5	13.8	7	9	10	10
55116 00 003	4	M7x1	4.8	16.5	14.4	7	9	10	10
55116 00 004	4	1/8	5.4	16.5	15	7	13	10	10
55116 00 005	4	1/4	7.1	16.5	16.6	9	16	10	10
55116 00 006	4	3/8	5.5	16.5	18	7	20	10	10
55116 00 007	5	M5	3.6	20	14.7	9	9	12	10
55116 00 009	5	1/8	5.4	20	15.8	9	13	12	10
55116 00 011	6	M5	3.6	20.5	14.7	9	9	12	10
55116 00 029	6	M7	5	20.5	15.5	9	9	12.5	10
55116 00 030	6	M10X1	5.5	20.5	15.5	9	13	12.5	10
55116 00 031	6	M12X1	7	20.5	18	9	16	12.5	10
55116 00 013	6	1/8	5.4	20.5	15.8	9	13	12	10
55116 00 014	6	1/4	7.1	20.5	17.5	9	16	12	10
55116 00 015	6	3/8	8.1	20.5	19	9	20	12	10
55116 00 016	6	1/2	9.6	20.5	21	9	25	12	10
55116 00 032	8	M10X1	5.5	22.5	19.5	10	13	14	10
55116 00 033	8	M12X1	7.5	22.5	19	10	16	14	10
55116 00 017	8	1/8	5.4	22	19.4	10	13	14	10
55116 00 018	8	1/4	7.1	22	18.7	10	16	14	10
55116 00 019	8	3/8	8.1	22	20.1	10	20	14	10
55116 00 020	8	1/2	9.6	22	22.1	10	25	14	10
55116 00 034	10	1/8	5.5	26.5	21	13	16	17	10
55116 00 021	10	1/4	7.1	26.5	22.8	13	16	17	10
55116 00 022	10	3/8	8.1	26.5	22.3	13	20	17	10
55116 00 023	10	1/2	9.6	26.5	23.8	13	25	17	10
55116 00 024	12	1/4	7.1	30	24.1	16	16	20	10
55116 00 025	12	3/8	8.1	30	23.6	16	20	20	10
55116 00 026	12	1/2	9.6	30	25.1	16	25	20	10
55116 00 027	14	3/8	8.1	31	28.1	18	20	21	10
55116 00 028	14	1/2	9.6	31	26.1	18	25	21	10
55116 00 035	16	3/8	8.1	32.8	33.8	20	22	24	10
55116 00 036	16	1/2	9.6	32.8	35.8	20	25	24	10

55126

RACCORDO A L ORIENTABILE PROLUNGATO MASCHIO CILINDRICO

EXTENDED ORIENTING ELBOW MALE ADAPTOR (PARALLEL)

VERLÄNGERTE WINKELVERSCHRAUBUNG ZYLINDRISCH

EQUERRE PROLONGÉE MÂLE ORIENTABLE CYLINDRIQUE

RACOR A L ORIENTABLE PROLONGADO MACHO CIL. CON TORICA

CONEXÃO COTOVELO ORIENTÁVEL PROLONGADO ROSCA MACHO PARALELA

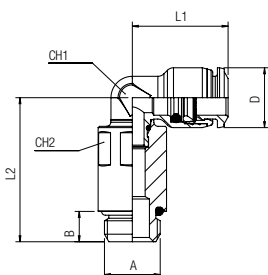

Code	Tube	A	B	L1	L2	CH1	CH2	D	Pack.
55126 00 002	4	M5	3.6	16.5	27.5	7	8	10	10
55126 00 004	4	1/8	5.4	16.5	28.5	7	12	10	10
55126 00 008	6	M5	3.6	20.5	29.5	9	8	12.5	10
55126 00 025	6	M7X1	4.8	20.5	31	9	12	12.5	10
55126 00 009	6	1/8	5.4	20.5	29.5	9	12	12.5	10
55126 00 024	6	1/4	7	20.5	29.5	9	15	12.5	10
55126 00 013	8	1/8	5.4	22.5	34.5	10	12	14	10
55126 00 014	8	1/4	7.1	22.5	33.5	10	15	14	10
55126 00 015	8	3/8	8.1	22.5	34.5	10	12	14	10
55126 00 016	10	1/4	7.1	26.5	43	13	15	17	10
55126 00 017	10	3/8	8.1	26.5	43	13	15	17	10
55126 00 018	10	1/2	9.6	26.5	45	13	15	17	10
55126 00 019	12	1/4	7.1	31	45	16	15	20	10
55126 00 020	12	3/8	8.1	31	45	16	15	20	10
55126 00 021	12	1/2	9.6	31	46	16	15	20	10

55130

New

RACCORDO A L INTERMEDIO

ELBOW CONNECTOR

WINKELVERSCHRAUBUNG

RACCORD EQUERRE

RACOR A L INTERMEDIO

CONEXÃO EM "L" TUBO-TUBO

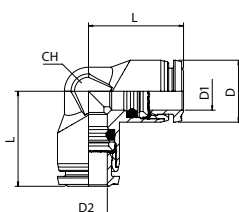

Code	D1	D2	L	D	CH	Pack.
55130 00 002	4	4	16.5	10	9	10
55130 00 003	5	5	20	12	11	10
55130 00 004	6	6	20.5	12	11	10
55130 00 009	8	6	22.5	14	13	10
55130 00 005	8	8	22	14	13	10
55130 00 012	10	6	26	17	16	10
55130 00 010	10	8	26	17	16	10
55130 00 006	10	10	26.5	17	16	10
55130 00 011	12	10	30.5	20	19	10
55130 00 007	12	12	30	20	19	10
55130 00 008	14	14	30.5	21	20	10
55130 00 013	16	16	32.8	24	20	10

55140

RACCORDO A L CON CODA LISCIA CORTA

ORIENTING ELBOW

WINKELSTECKVERSCHRAUBUNG KURZ

RACCORD EQUERRE ENCLIQUETABLE

RACOR A L ORIENTABLE CON ESPIGA LISA CORTA

CONEXÃO EM "L" COM PONTA LISA E CURTA

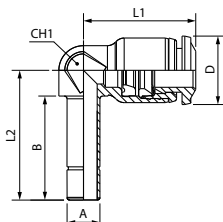

Code	Tube	A	B	L1	L2	CH1	D	Pack.
55140 00 001	4	4	17	16.5	20.8	7	10	10
55140 00 002	4	6	19	16.5	22.8	7	10	10
55140 00 005	6	6	19	20.5	23.7	9	12.5	10
55140 00 006	6	4	17	20.5	21.7	9	12.5	10
55140 00 012	6	8	20	22.5	26	10	14	10
55140 00 007	8	8	20	22	26	10	14	10
55140 00 008	8	10	21.8	22	27.6	10	14	10
55140 00 009	10	10	22.5	26.5	30	13	17	10
55140 00 010	10	12	24.7	26.5	32.2	13	17	10
55140 00 011	12	12	25.5	30	33.5	16	20	10

55150

RACCORDO A L CON CODA LISCIA LUNGA

ORIENTING ELBOW

WINKELSTECKVERSCHRAUBUNG LANG

RACCORD EQUERRE ENCLIQUETABLE, RALLONGÉ

RACOR A L ORIENTABLE CON ESPIGA LISA LARGA

CONEXÃO EM "L" COM PONTA LISA E LONGA

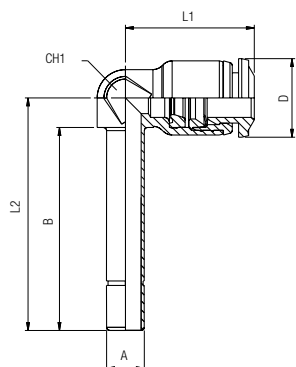

Code	Tube	A	B	L1	L2	CH1	D	Pack.
55150 00 001	4	4	28	16.5	31.8	7	10	10
55150 00 002	4	6	30.5	16.5	34.3	7	10	10
55150 00 005	6	6	32.3	20.5	37	9	12.5	10
55150 00 006	6	4	30	20.5	34.7	9	12.5	10
55150 00 007	8	8	36	22	42	10	14	10
55150 00 008	8	10	37.5	22	43.1	10	14	10
55150 00 009	10	10	40.8	26.5	48.3	13	17	10
55150 00 010	10	12	43.2	26.5	50.7	13	17	10
55150 00 011	12	12	47	31	55	16	20	10

55160

RACCORDO A 45° CON CODA LISCIA CORTA

45° ORIENTING ELBOW

WINKELSTECKVERSCHRAUBUNG 45°

RACCORD EQUERRE ENCLIQUETABLE À 45°

RACOR A 45° CON ESPIGA LISA CORTA

CONEXÃO A 45° COM PONTA LISA CURTA

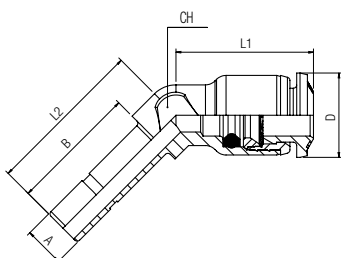

Code	Tube	A	B	L1	L2	CH1	D	Pack.
55160 00 001	4	4	17	12.5	21	7	10	10
55160 00 005	6	6	19	20.5	23.5	9	12	10
55160 00 007	8	8	20	22	25	10	14	10
55160 00 009	10	10	22.5	26.5	30	13	17	10
55160 00 011	12	12	25.5	30	33.5	16	20	10

55170

RACCORDO ORIENTABILE A 45° MASCHIO "UNIVERSAL SHORT"

45° ORIENTING ELBOW MALE ADAPTOR "UNIVERSAL SHORT"
 WINKELVERSCHRAUBUNG 45° KONISCH (DREHBAR) "UNIVERSAL SHORT"
 EQUERRE À 45° ORIENTABLE MÂLE, CONIQUE "UNIVERSAL SHORT"
 RACOR A 45° ORIENTABLE MACHO "UNIVERSAL SHORT"
 CONEXÃO ORIENTÁVEL A 45° ROSCA MACHO "UNIVERSAL SHORT"

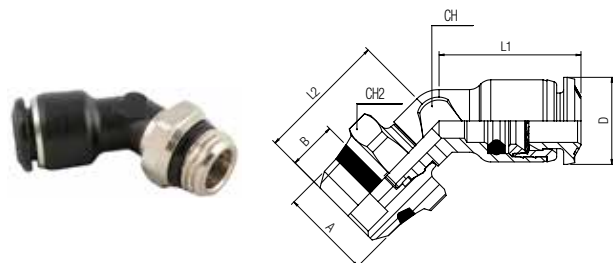

Code	Tube	A	B	L1	L2	CH1	CH2	D	Pack.
55170 00 001	4	1/8	5.5	12.5	16.5	7	13	10	10
55170 00 004	6	1/8	5.5	20.5	17.5	9	13	12	10
55170 00 005	6	1/4	7	20.5	18.9	9	15	12	10
55170 00 008	8	1/8	5.5	22	18.5	10	13	14	10
55170 00 009	8	1/4	7	22	20	10	15	14	10
55170 00 010	8	3/8	7.5	22	20.5	10	17	14	10
55170 00 012	10	1/4	7	26.5	21.8	13	16	17	10
55170 00 013	10	3/8	7.5	26.5	21.8	13	17	17	10
55170 00 014	10	1/2	9	26.5	24.3	13	21	17	10
55170 00 015	12	1/4	7	30	23.1	16	16	20	10
55170 00 016	12	3/8	7.5	30	23.1	16	17	20	10
55170 00 017	12	1/2	9	30	25.6	16	21	20	10

55175

RACCORDO ORIENTABILE A 45° MASCHIO CILINDRICO

45° ORIENTING ELBOW MALE ADAPTOR (PARALLEL)
 WINKELVERSCHRAUBUNG 45° ZYLINDRISCH (DREHBAR)
 EQUERRE À 45° ORIENTABLE MÂLE, CYLINDRIQUE
 RACOR A 45° ORIENTABLE MACHO CILINDRICO CON TORICA
 CONEXÃO ORIENTÁVEL A 45° ROSCA MACHO PARALELA

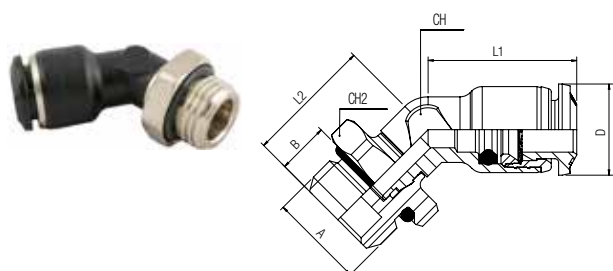

Code	Tube	A	B	L1	L2	CH1	CH2	D	Pack.
55175 00 002	4	M5	3.6	12.5	13.8	7	9	10	10
55175 00 004	4	1/8	5.4	12.5	15	7	13	10	10
55175 00 011	6	M5	3.6	20.5	14.7	9	9	12	10
55175 00 013	6	1/8	5.4	20.5	15.8	9	13	12	10
55175 00 014	6	1/4	7.1	20.5	17.5	9	16	12	10
55175 00 017	8	1/8	5.4	22	19.4	10	13	14	10
55175 00 018	8	1/4	7.1	22	18.7	10	16	14	10
55175 00 019	8	3/8	8.1	22	20.1	10	20	14	10
55175 00 021	10	1/4	7.1	26.5	22.8	13	16	17	10
55175 00 022	10	3/8	8.1	26.5	22.3	13	20	17	10
55175 00 023	10	1/2	9.6	26.5	23.8	13	25	17	10
55175 00 024	12	1/4	7.1	30	24.1	16	16	20	10
55175 00 025	12	3/8	8.1	30	23.6	16	20	20	10
55175 00 026	12	1/2	9.6	30	25.1	16	25	20	10

55180

RACCORDO INTERMEDIO A 45°

45° ELBOW CONNECTOR
 WINKELVERSCHRAUBUNG 45°
 RACCORD EQUERRE À 45°
 RACOR INTERMEDIO 45°
 CONEXÃO INTERMEDIÁRIA A 45°

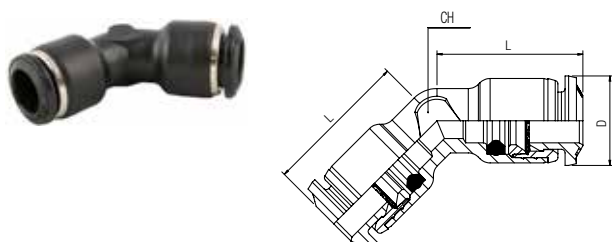

Code	Tube	L	CH	D	Pack.
55180 00 002	4	16.5	7	10	10
55180 00 004	6	20.5	9	12	10
55180 00 005	8	22	10	14	10
55180 00 006	10	26.5	13	17	10
55180 00 007	12	30	16	20	10

55211

New

RACCORDO A T ORIENTABILE MASCHIO "UNIVERSAL SHORT"

ORIENTING TEE MALE ADAPTOR "UNIVERSAL SHORT" - CENTRE LEG
 T-EINSCHRAUBVERSCHRAUBUNG KONISCH (DREHBAR) "UNIVERSAL SHORT"
 TÉ ORIENTABLE À PIQUAGE MÂLE CENTRAL, CONIQUE "UNIVERSAL SHORT"
 RACOR A T ORIENTABLE MACHO CENTRAL CÓNICO "UNIVERSAL SHORT"
 CONEXÃO EM "T" CENTRAL ORIENTÁVEL COM ROSCA MACHO "UNIVERSAL SHORT"

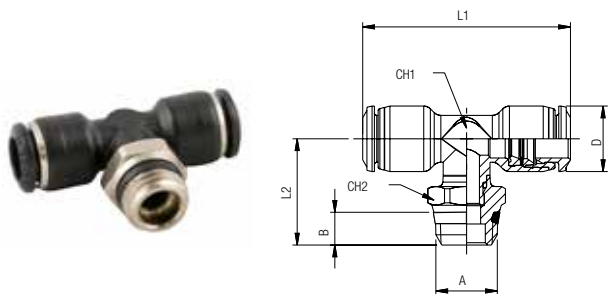

Code	Tube	A	B	L1	L2	CH1	CH2	D	Pack.
55211 00 001	4	1/8	5.5	33	18.5	7	13	10	10
55211 00 002	4	1/4	7	33	20	7	15	10	10
55211 00 003	5	1/8	5.5	40	20	9	13	12.5	10
55211 00 004	6	1/8	5.5	41	20	9	13	12.5	10
55211 00 005	6	1/4	7	41	21.5	9	15	12.5	10
55211 00 008	8	1/8	5.5	44	21	10	13	14	10
55211 00 009	8	1/4	7	44	22.5	10	15	14	10
55211 00 010	8	3/8	7.5	44	23	10	17	14	10
55211 00 012	10	1/4	7	53	25.5	13	16	17	10
55211 00 013	10	3/8	7.5	53	25.5	13	17	17	10
55211 00 014	10	1/2	9	53	28	13	21	17	10
55211 00 015	12	1/4	7	60	27	16	16	20	10
55211 00 016	12	3/8	7.5	60	27	16	17	20	10
55211 00 017	12	1/2	9	60	29.5	16	21	20	10
55211 00 018	14	3/8	7.5	61	30	18	20	21	10
55211 00 019	14	1/2	9	61	30.5	18	21	21	10
55211 00 020	16	3/8	7.5	65.6	33.8	20	22	24	10
55211 00 021	16	1/2	9	65.6	34.8	20	22	24	10

55216

New

RACCORDO A T ORIENTABILE MASCHIO CILINDRICO

ORIENTING TEE MALE ADAPTOR (PARALLEL) - CENTRE LEG
 T-EINSCHRAUBVERSCHRAUBUNG ZYLINDRISCH (DREHBAR)
 TÉ ORIENTABLE À PIQUAGE MÂLE CENTRAL, CYLINDRIQUE
 RACOR A T ORIENTABLE MACHO CENTRAL CILÍNDRICO CON TÓRICA
 CONEXÃO MACHO EM "T" ORIENTÁVEL COM ROSCA PARALELA

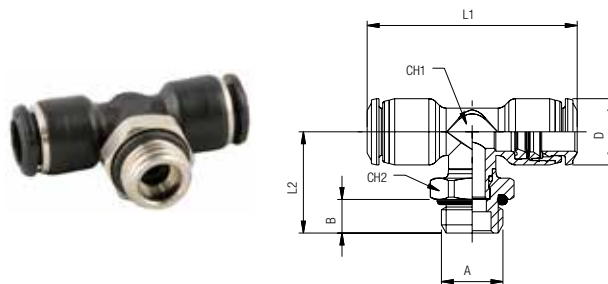

Code	Tube	A	B	L1	L2	CH1	CH2	D	Pack.
55216 00 002	4	M5	3.6	33	15.5	7	9	10	10
55216 00 004	4	1/8	5.4	33	17.1	7	13	10	10
55216 00 005	4	1/4	7.1	33	18.8	7	16	10	10
55216 00 007	5	M5	3.6	40	14.7	9	9	12	10
55216 00 009	5	1/8	5.4	40	18.4	9	13	12	10
55216 00 011	6	M5	3.6	41	14.7	9	9	12.5	10
55216 00 013	6	1/8	5.4	41	18.4	9	13	12.5	10
55216 00 014	6	1/4	7.1	41	20	9	16	12.5	10
55216 00 017	8	1/8	5.4	44	22.1	10	13	14	10
55216 00 018	8	1/4	7.1	44	21.4	10	16	14	10
55216 00 019	8	3/8	8.1	44	22.8	10	20	14	10
55216 00 021	10	1/4	7.1	53	26.7	13	16	17	10
55216 00 022	10	3/8	8.1	53	26.2	13	20	17	10
55216 00 023	10	1/2	9.6	53	27.7	13	25	17	10
55216 00 024	12	1/4	7.1	61.5	28.1	16	16	20	10
55216 00 025	12	3/8	8.1	61.5	27.6	16	20	20	10
55216 00 026	12	1/2	9.6	61.5	29.1	16	25	20	10
55216 00 027	14	3/8	8.1	61	31.8	18	20	21	10
55216 00 028	14	1/2	9.6	61	29.8	18	25	21	10
55216 00 029	16	3/8	8.1	65.6	33.8	20	22	24	10
55216 00 030	16	1/2	9.6	65.6	35.8	20	25	24	10

55223

RACCORDO A T ORIENTABILE MASCHIO LATERALE "UNIVERSAL SHORT"

ORIENTING TEE MALE ADAPTOR "UNIVERSAL SHORT" OFF - SET LEG
 L-EINSCHRAUBVERSCHRAUBUNG KONISCH (DREHBAR) "UNIVERSAL SHORT"
 TÉ ORIENTABLE À PIQUAGE LATÉRAL, CONIQUE "UNIVERSAL SHORT"
 RACOR A T ORIENTABLE MACHO LATERAL CÓNICO "UNIVERSAL SHORT"
 CONEXÃO EM "T" LATERAL ORIENTÁVEL COM ROSCA MACHO "UNIVERSAL SHORT"

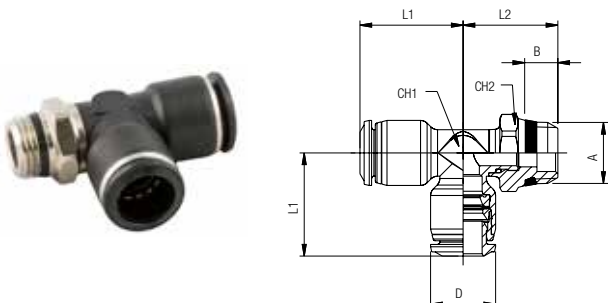

Code	Tube	A	B	L1	L2	CH1	CH2	D	Pack.
55223 00 001	4	1/8	5.5	16.5	18	7	13	10	10
55223 00 002	4	1/4	7	16.5	19.5	7	15	10	10
55223 00 003	5	1/8	5.5	20	17.5	9	13	12	10
55223 00 004	6	1/8	5.5	20.5	17.5	9	13	12.5	10
55223 00 005	6	1/4	7	20.5	19	9	15	12.5	10
55223 00 008	8	1/8	5.5	22	19	10	13	14	10
55223 00 009	8	1/4	7	22	20.5	10	15	14	10
55223 00 010	8	3/8	7.5	22	21	10	17	14	10
55223 00 012	10	1/4	7	26.5	22	13	16	17	10
55223 00 013	10	3/8	7.5	26.5	22	13	17	17	10
55223 00 014	10	1/2	9	26.5	24.5	13	21	17	10
55223 00 015	12	1/4	7	31	23	16	16	20	10
55223 00 016	12	3/8	7.5	31	23	16	17	20	10
55223 00 017	12	1/2	9	31	25.5	16	21	20	10
55223 00 018	14	3/8	7.5	30.5	26.5	18	20	21	10
55223 00 019	14	1/2	9	30.5	27	18	21	21	10

55226

RACCORDO A T ORIENTABILE MASCHIO LATERALE CILINDRICO

ORIENTING TEE MALE ADAPTOR (PARALLEL) - OFF - SET LEG

L-EINSCHRAUBVERSCHRAUBUNG ZYLINDRISCH (DREHBAR)

TÉ ORIENTABLE À PIQUAGE LATÉRAL, CYLINDRIQUE

RACOR A T ORIENTABLE MACHO LATERAL CILÍNDRICO CON TÓRICA

CONEXÃO MACHO EM "T" LATERAL ORIENTÁVEL COM ROSCA PARALELA

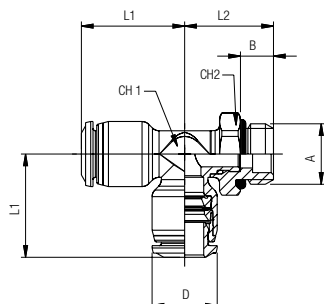

Code	Tube	A	B	L1	L2	CH1	CH2	D	Pack.
55226 00 002	4	M5	3.6	16.5	15.5	7	9	10	10
55226 00 004	4	1/8	5.4	16.5	16.6	7	13	10	10
55226 00 005	4	1/4	7.1	16.5	18.3	7	16	10	10
55226 00 007	5	M5	3.6	20	14.7	9	9	12	10
55226 00 009	5	1/8	5.4	20	15.8	9	13	12	10
55226 00 011	6	M5	3.6	20.5	14.7	9	9	12.5	10
55226 00 013	6	1/8	5.4	20.5	15.8	9	13	12.5	10
55226 00 014	6	1/4	7.1	20.5	17.5	9	16	12.5	10
55226 00 017	8	1/8	5.4	22	19.8	10	13	14	10
55226 00 018	8	1/4	7.1	22	19.1	10	16	14	10
55226 00 019	8	3/8	8.1	22	20.5	10	20	14	10
55226 00 021	10	1/4	7.1	26.5	22.8	13	16	17	10
55226 00 022	10	3/8	8.1	26.5	22.3	13	20	17	10
55226 00 023	10	1/2	9.6	26.5	23.8	13	25	17	10
55226 00 024	12	1/4	7.1	31	24.1	16	16	20	10
55226 00 025	12	3/8	8.1	31	23.6	16	20	20	10
55226 00 026	12	1/2	9.6	31	25.1	16	25	20	10
55226 00 027	14	3/8	8.1	30.5	28.1	18	20	21	10
55226 00 028	14	1/2	9.6	30.5	26.1	18	25	21	10

55230

RACCORDO A T INTERMEDIO

TEE CONNECTOR

T-ANSCHLUSS

RACCORD TÉ

RACOR A T INTERMEDIO

CONEXÃO EM "T" TUBO-TUBO

New

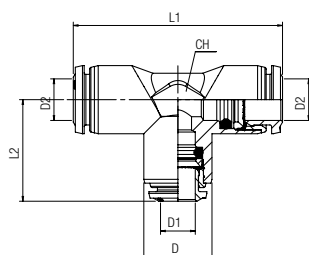

Code	Tube	L1	L2	CH	D	D1	D2	Pack.
55230 00 002	4	33	16.5	9	10	4	4	10
55230 00 019	4-6-4	40	20.5	11	12.5	6	4	10
55230 00 003	5	40	20	11	12	5	5	10
55230 00 004	6	41	20.5	11	12	6	6	10
55230 00 009	6-4-6	41	20	11	12.5	4	6	10
55230 00 018	6-8-6	45	22.5	13	14	8	6	10
55230 00 005	8	44	22	13	14	8	8	10
55230 00 021	8-4-8	45	22	13	14	4	8	10
55230 00 010	8-6-8	45	22.5	13	14	6	8	10
55230 00 015	8-10-8	52	26.5	16	17	10	8	10
55230 00 006	10	53	26.5	16	17	10	10	10
55230 00 011	10-8-10	53	26	16	17	8	10	10
55230 00 017	10-12-10	59.5	30.5	19	20	12	10	10
55230 00 007	12	61.5	30	19	20	12	12	10
55230 00 012	12-10-12	61.5	30	19	20	10	12	10
55230 00 008	14	61	30.5	20	21	14	14	10
55230 00 016	14-8-14	61.5	29.5	20	21	8	14	10
55230 00 013	14-10-14	61	30	20	21	10	14	10
55230 00 014	14-12-14	61	30.5	20	21	12	14	10
55230 00 020	16	65.6	32.8	20	24	16	16	10

55235

RACCORDO A T CON ADATTATORE LATERALE

PLUG-IN EQUAL RUN TEE

T-STECKANSCHLUSS SEITLICH STECKBAR

RACCORD EN TE ENCLIQUETABLE LATERAL

RACOR A T CON ADAPTADOR LATERAL

CONEXÃO EM "T" COM ADAPTADOR LATERAL

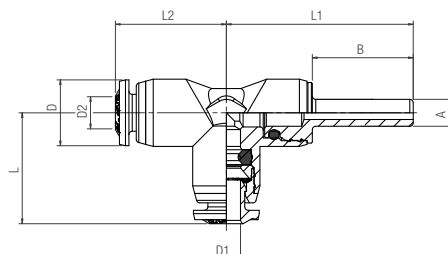

Code	D1	D2	A	D	B	L	L1	L2	CH	Pack.
55235 00 002	4	4	4	10	15	28	16.5	16.5	9	10
55235 00 004	6	6	6	12.5	17	33.5	20.5	20.5	11	10
55235 00 005	8	8	8	14	18	36.5	22.5	22.5	13	10
55235 00 006	10	10	10	17	22	44	26.5	26.5	16	10
55235 00 007	12	12	12	20	24.5	31	50	31	19	10
55235 00 009	4	6	6	12.5	17	20	33.5	20.5	11	10
55235 00 010	6	8	8	14	22.5	22.5	36.5	22.5	13	10
55235 00 011	8	10	10	17	22	26	44	26.5	16	10
55235 00 012	10	12	12	20	24.5	30	50	31	19	10

55237

RACCORDO A T CON ADATTATORE CENTRALE

PLUG-IN EQUAL CENTRE TEE
 T-STECKANSCHLUSS MITTIG STECKBAR
 RACCORD EN TE ENCLIQUETABLE AU CENTRE
 RACOR A T CON ADAPTADOR CENTRAL
 CONEXÃO EM "T" COM ADAPTADOR CENTRAL

Code	D1	A	D	B	L	L1	CH	Pack.
55237 00 009	6	4	12.5	15	31.5	41	11	10
55237 00 010	8	6	14	17	35.5	45	13	10
55237 00 011	10	8	17	18	40	53	16	10
55237 00 012	12	10	20	22	47.5	61	19	10

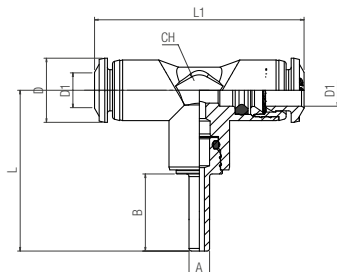

55240

RACCORDO A T ORIENTABILE CON CODA LISCIA CORTA

ORIENTING TEE
 T-STECKANSCHLUSS
 RACCORD TÉ ENCLIQUETABLE
 RACOR A T ORIENTABLE CON ESPIGA LISA CORTA
 CONEXÃO EM "T" COM PONTA LISA E CURTA

Code	Tube	A	B	L1	L2	CH	D	Pack.
55240 00 001	4	4	17	33	20.7	7	10	10
55240 00 002	4	6	19	33	22.7	7	10	10
55240 00 005	6	6	19	41	23.7	9	12.5	10
55240 00 006	6	4	17	41	21.7	9	12.5	10
55240 00 007	8	8	20	44	26	10	14	10
55240 00 008	8	10	22.2	44	28	10	14	10
55240 00 009	10	10	22.5	53	30	13	17	10
55240 00 010	10	12	25	53	32.2	13	17	10
55240 00 011	12	12	25.5	61.5	33.5	16	20	10

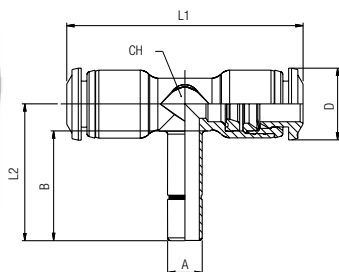

55310

RACCORDO A Y INTERMEDIO

Y CONNECTOR
 Y-ANSCHLUSS
 RACCORD Y SIMPLE
 RACOR A Y INTERMEDIO
 CONEXÃO EM "Y" TUBO-TUBO

Code	D1	D2	A	L	CH	D	Pack.
55310 00 002	4	4	11	31.5	10	10	10
55310 00 004	6	6	13.5	37	12	12	10
55310 00 008	6	4	13.5	36.5	12	12.5	10
55310 00 005	8	8	15.5	40	14	14	10
55310 00 009	8	6	15.5	41	14	14	10
55310 00 006	10	10	19	48.5	17	18	10
55310 00 010	10	8	19	47.5	17	18	10
55310 00 007	12	12	22	57.5	20	20	10
55310 00 011	12	8	22	57.5	20	20	10

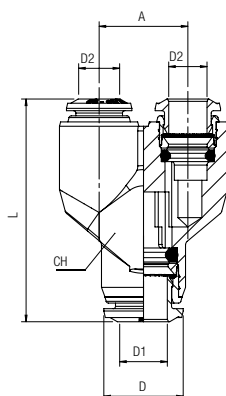

55315

RACCORDO A Y CON ADATTATORE

PLUG-IN Y CONNECTOR

Y-STECKANSCHLUSS

RACCORD Y ENCLIQUETABLE

RACOR A Y INTERMEDIO CON ADAPTADOR

CONEXÃO EM "Y" COM ADAPTADOR

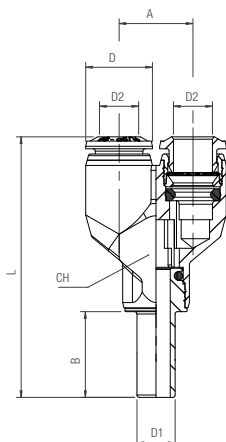

Code	D1	D2	A	L	CH	D	B	Pack.
55315 00 002	4	4	11	43	10	10	15	10
55315 00 008	6	4	13.5	49.5	12	12.5	17	10
55315 00 004	6	6	13.5	50	12	12.5	17	10
55315 00 009	8	6	15.5	55	14	12.5	18	10
55315 00 005	8	8	15.5	55	14	14	18	10
55315 00 010	10	8	19	65	17	17	22	10
55315 00 006	10	10	19	65.5	17	17	22	10
55315 00 007	12	12	22	78	20	20	24.5	10

55320

RACCORDO A Y ORIENTABILE MASCHIO "UNIVERSAL SHORT"

ORIENTING Y MALE ADAPTOR "UNIVERSAL SHORT"

Y-EINSCHRAUBVERSCHRAUBUNG KONISCH (DREHBAR) "UNIVERSAL SHORT"

Y SIMPLE ORIENTABLE MÂLE, CONIQUE "UNIVERSAL SHORT"

RACOR A Y ORIENTABLE MACHO CÔNICO "UNIVERSAL SHORT"

CONEXÃO MACHO EM "Y" ORIENTÁVEL COM ROSCA "UNIVERSAL SHORT"

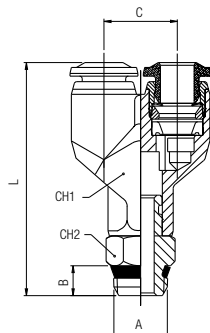

Code	Tube	A	B	C	L	CH1	CH2	Pack.
55320 00 002	4	1/8	5.5	11	38	10	11	10
55320 00 007	4	1/4	7	11	40.5	10	14	10
55320 00 003	6	1/8	5.5	13.5	43	12	11	10
55320 00 004	6	1/4	7	13.5	45.5	12	14	10
55320 00 005	8	1/8	5.5	15.5	46.5	14	11	10
55320 00 006	8	1/4	7	15.5	49	14	14	10
55320 00 008	8	3/8	7.5	15.5	49.5	14	17	10
55320 00 009	10	1/4	7	19	56.5	17	14	10
55320 00 010	10	3/8	7.5	19	57.5	17	17	10
55320 00 011	10	1/2	9	19	60	17	21	10
55320 00 012	12	3/8	7.5	22	66.5	20	17	10
55320 00 013	12	1/2	9	22	68	20	21	10

55325

RACCORDO A Y ORIENTABILE MASCHIO CILINDRICO

ORIENTING Y MALE ADAPTOR (PARALLEL)

Y-EINSCHRAUBVERSCHRAUBUNG ZYLINDRISCH (DREHBAR)

Y SIMPLE ORIENTABLE MÂLE, CYLINDRIQUE

RACOR A Y ORIENTABLE MACHO CILÍNDRICO CON TÓRICA

CONEXÃO MACHO EM "Y" ORIENTÁVEL COM ROSCA PARALELA

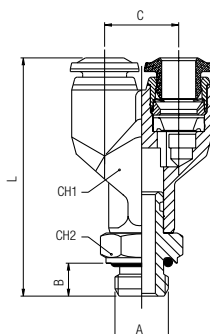

Code	Tube	A	B	C	L	CH1	CH2	Pack.
55325 00 002	4	M5	4	11	36.5	10	10	10
55325 00 003	4	1/8	6	11	38.5	10	13	10
55325 00 009	4	1/4	8	11	40.5	10	16	10
55325 00 004	6	M5	4	13.5	41.5	12	10	10
55325 00 005	6	1/8	6	13.5	43.5	12	13	10
55325 00 006	6	1/4	8	13.5	46.5	12	16	10
55325 00 007	8	1/8	6	15.5	47	14	13	10
55325 00 008	8	1/4	8	15.5	50	14	16	10
55325 00 010	8	3/8	9	15.5	52	14	20	10
55325 00 011	10	1/4	8	19	59.5	17	16	10
55325 00 012	10	3/8	9	19	59.5	17	20	10
55325 00 013	10	1/2	10	19	62	17	24	10
55325 00 014	12	3/8	9	22	68.5	20	20	10
55325 00 015	12	1/2	10	22	71	20	24	10

55330

RACCORDO MULTIPLO A Y INTERMEDIO

Y CONNECTOR MANIFOLD

Y-4 FACH-VERTEILER

RACCORD Y DOUBLE

RACOR A Y MÚLTIPLE INTERMEDIO

CONEXÃO EM "Y" TUBO-TUBO COM 4 SAÍDAS

Code	D1	D2	C	L	F	H	Pack.
55330 00 001	4	4	11	33.5	3.3	21.5	10
55330 00 002	4	6	11	34.5	3.3	21.5	10
55330 00 003	6	6	13.5	39.5	3.3	26.8	10
55330 00 004	6	8	13.5	40	3.3	26.8	10

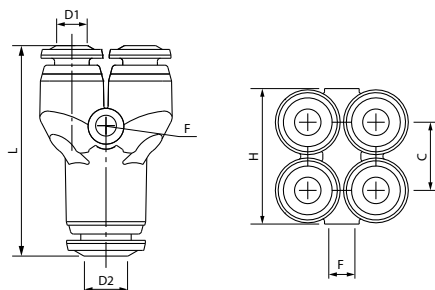

55340

RACCORDO MULTIPLO A Y ORIENTABILE MASCHIO "UNIVERSAL SHORT"

Y CONNECTOR ORIENTING MALE ADAPTOR "UNIVERSAL SHORT"

Y-4 FACH-EINSCHRAUBVERSCHRAUBUNG KONISCH (DREHBAR) "UNIVERSAL SHORT"

Y DOUBLE ORIENTABLE MÂLE, CONIQUE "UNIVERSAL SHORT"

RACOR A Y MÚLTIPLE ORIENTABLE MACHO CÓNICO "UNIVERSAL SHORT"

CONEXÃO MACHO EM "Y" ORIENTÁVEL COM 4 SAÍDAS E ROSCA "UNIVERSAL SHORT"

Code	Tube	A	B	C	L	H	CH	F	Pack.
55340 00 001	4	1/8	5.5	11	39.5	21.5	11	3.3	10
55340 00 002	4	1/4	7	11	42	21.5	14	3.3	10
55340 00 003	6	1/8	5.5	13.5	46.5	26.8	11	3.3	10
55340 00 004	6	1/4	7	13.5	48	26.8	14	3.3	10

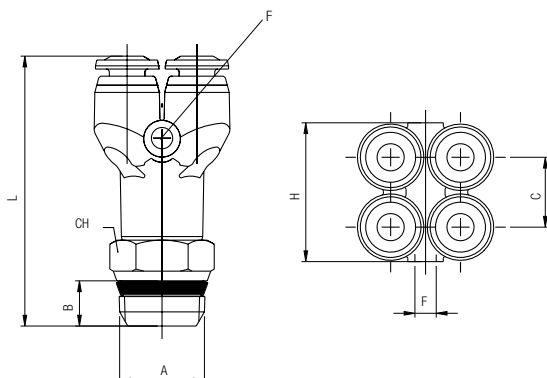

55345

RACCORDO MULTIPLO A Y ORIENTABILE MASCHIO CILINDRICO

Y CONNECTOR ORIENTING MALE ADAPTOR (PARALLEL)

Y-4 FACH-EINSCHRAUBVERSCHRAUBUNG ZYLINDRISCH (DREHBAR)

Y DOUBLE ORIENTABLE MÂLE, CYLINDRIQUE

RACOR A Y MÚLTIPLE ORIENTABLE MACHO CILÍNDRICO CON TÓRICA

CONEXÃO MACHO EM "Y" ORIENTÁVEL COM 4 SAÍDAS E ROSCA PARALELA

Code	Tube	A	B	C	L	H	CH	F	Pack.
55345 00 001	4	1/8	6	10.8	40	21.5	13	3.3	10
55345 00 002	4	1/4	8	10.8	42	21.5	16	3.3	10
55345 00 003	6	1/8	6	13.3	47	26.8	13	3.3	10
55345 00 004	6	1/4	8	13.3	49	26.8	16	3.3	10

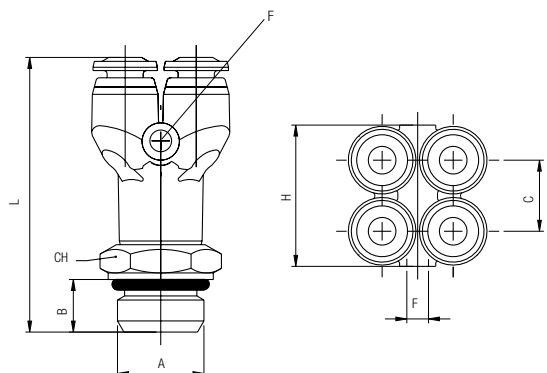

55350

RACCORDO MULTIPLO DI RIDUZIONE

REDUCTION MANIFOLD

T-MEHRFACHVERTEILER REDUZIERT

MULTI-TÉ RÉDUIT

RACOR DISTRIBUIDOR MÚLTIPLE DE REDUCCIÓN

CONEXÃO DE REDUÇÃO MÚLTIPLA

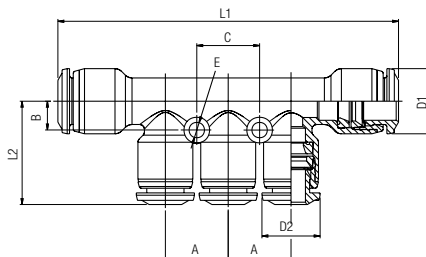

Code	Tube	A	B	L1	L2	C	D1	D2	E	Pack.
55350 00 001	6-4	13.5	6	74	22	13.5	14	12	3.3	10
55350 00 002	8-4	13.5	6	73	22	13.5	14	12	3.3	10
55350 00 003	8-6	13.5	6	73	22.5	13.5	14	12.5	3.3	10
55350 00 004	10-6	15	7	83	24	15	17	14	3.3	10
55350 00 005	10-8	15	7	83	23	15	17	14	3.3	10

55360

RACCORDO MULTIPLO DI RIDUZIONE ORIENTABILE MASCHIO "UNIVERSAL SHORT"

REDUCTION MANIFOLD ORIENTING MALE ADAPTOR "UNIVERSAL SHORT"

T-MEHRFACHVERSCHRAUBUNG REDUZIERT KONISCH (DREHBAR) "UNIVERSAL SHORT"

MULTI-TÉ RÉDUIT, PIQUAGE LATÉRAL, CONIQUE "UNIVERSAL SHORT"

RACOR DISTRIBUIDOR MÚLTIPLE DE REDUCCIÓN ORIENTABLE MACHO CÓNICO "UNIVERSAL SHORT"

CONEXÃO MACHO DE REDUÇÃO MÚLTIPLA COM ROSCA "UNIVERSAL SHORT"

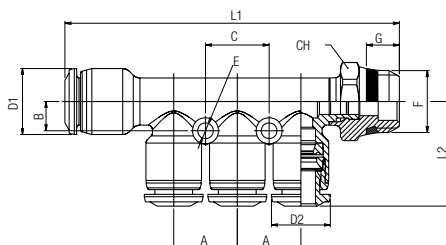

Code	Tube	F	A	B	L1	L2	C	D1	D2	E	G	H	Pack.
55360 00 001	6-4	1/8	13.5	6	70	22	13.5	14	12	3.3	5.5	13	10
55360 00 002	6-4	1/4	13.5	6	71.4	22	13.5	14	12	3.3	7	15	10
55360 00 003	8-4	1/8	13.5	6	70	22	13.5	14	12	3.3	5.5	13	10
55360 00 004	8-4	1/4	13.5	6	71.4	22	13.5	14	12	3.3	7	15	10
55360 00 005	8-6	1/8	13.5	6	70	22	13.5	14	12.5	3.3	5.5	13	10
55360 00 006	8-6	1/4	13.5	6	71.4	22	13.5	14	12.5	3.3	7	15	10
55360 00 007	10-6	1/4	15	7	81.5	24	15	17	14	3.3	7	16	10
55360 00 008	10-6	3/8	15	7	81.5	24	15	17	14	3.3	7.5	17	10
55360 00 009	10-8	1/4	15	7	81.5	23	15	17	14	3.3	7	16	10
55360 00 010	10-8	3/8	15	7	81.5	23	15	17	14	3.3	7.5	17	10

55365

RACCORDO MULTIPLO DI RIDUZIONE ORIENTABILE MASCHIO CILINDRICO

REDUCTION MANIFOLD ORIENTING MALE ADAPTOR (PARALLEL)

T-MEHRFACHVERSCHRAUBUNG REDUZIERT ZYLINDRISCH (DREHBAR)

MULTI-TÉ RÉDUIT, PIQUAGE LATÉRAL, CYLINDRIQUE

RACOR DISTRIBUIDOR MÚLTIPLE DE REDUCCIÓN ORIENTABLE MACHO CILÍNDRICO CON TÓRICA

CONEXÃO MACHO DE REDUÇÃO MÚLTIPLA COM ROSCA PARALELA

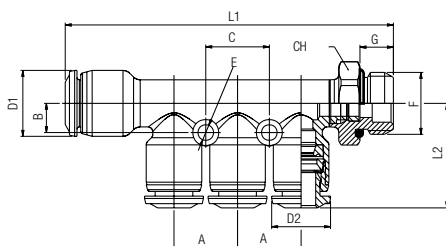

Code	Tube	F	A	B	L1	L2	C	D1	D2	E	G	H	Pack.
55365 00 001	6-4	1/8	13.5	6	70.7	21.8	13.5	14	12	3.3	5.4	13	10
55365 00 002	6-4	1/4	13.5	6	70	21.8	13.5	14	12	3.3	7.1	16	10
55365 00 003	8-4	1/8	13.5	6	70.7	21.8	13.5	14	12	3.3	5.4	13	10
55365 00 004	8-4	1/4	13.5	6	70	21.8	13.5	14	12	3.3	7.1	16	10
55365 00 005	8-6	1/8	13.5	6	70.7	22.3	13.5	14	12.5	3.3	5.4	13	10
55365 00 006	8-6	1/4	13.5	6	70	22.3	13.5	14	12.5	3.3	7.1	16	10
55365 00 007	10-6	1/4	15	7	82.4	23.7	15	17	14	3.3	7.1	16	10
55365 00 008	10-6	3/8	15	7	82	23.7	15	17	14	3.3	8.1	20	10
55365 00 009	10-8	1/4	15	7	82.4	23.2	15	17	14	3.3	7.1	16	10
55365 00 010	10-8	3/8	15	7	82	23.2	15	17	14	3.3	8.1	20	10

55500

ANELLO ORIENTABILE A L
 SINGLE BANJO BODY
 RINGANSCHLUSS
 CORPS SIMPLE POUR BANJO
 ANILLO ORIENTABLE SIMPLE
 ANEL ORIENTÁVEL EM "L"

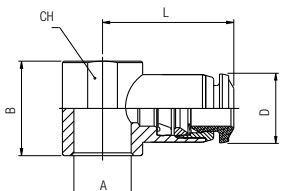

Code	Tube	A	B	L	CH	D	Pack.
55500 00 001	4	M5	14	19.5	9	10	10
55500 00 002	4	M6	14	19.5	9	10	10
55500 00 003	4	1/8	16.5	21.5	14	10	10
55500 00 018	4	1/4	18.5	23.5	18	12	10
55500 00 004	5	M5	14	20.5	9	12	10
55500 00 005	5	M6	14	20.5	9	12	10
55500 00 006	5	1/8	16.5	22.5	14	12	10
55500 00 007	5	1/4	18.5	25	18	12	10
55500 00 008	6	M5	14	21	9	12	10
55500 00 009	6	M6	14	21	9	12	10
55500 00 010	6	1/8	16.5	23	14	12	10
55500 00 011	6	1/4	18.5	25.5	18	12	10
55500 00 012	8	1/8	16.5	23.5	14	14	10
55500 00 013	8	1/4	18.5	26	18	14	10
55500 00 014	8	3/8	22	27.5	21	14	10
55500 00 019	10	1/4	18.5	31	18	17	10
55500 00 015	10	3/8	22	30.5	21	17	10
55500 00 016	12	3/8	22	32.5	21	20	10
55500 00 017	12	1/2	26	35	26	20	10

55510

ANELLO ORIENTABILE A T
 DOUBLE BANJO BODY
 DOPPELTER RINGANSCHLUSS
 CORPS DOUBLE POUR BANJO
 ANILLO ORIENTABLE DOBLE
 ANEL ORIENTÁVEL EM "T"

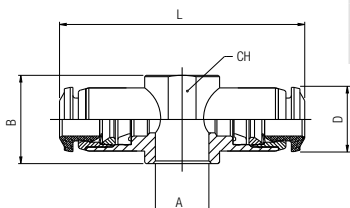

Code	Tube	A	B	L	CH	D	Pack.
55510 00 001	4	M5	14	39	9	10	10
55510 00 003	4	1/8	16.5	43	14	10	10
55510 00 006	5	1/8	16.5	45	14	12	10
55510 00 007	5	1/4	18.5	50	18	12	10
55510 00 010	6	1/8	16.5	46	14	12	10
55510 00 011	6	1/4	18.5	51	18	12	10
55510 00 012	8	1/8	16.5	47	14	14	10
55510 00 013	8	1/4	18.5	52	18	14	10

55520

ANELLO ORIENTABILE A Y
 DOUBLE BANJO BODY
 DOPPELTER RINGANSCHLUSS
 CORPS DOUBLE POUR BANJO
 ANILLO ORIENTABLE DOBLE
 ANEL ORIENTÁVEL EM "Y"

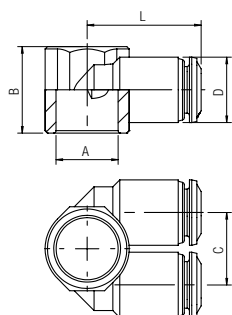

Code	Tube	A	B	C	L	D	Pack.
55520 00 001	4	1/8	16.5	13	21	12	10
55520 00 002	4	1/4	18.5	15.5	24	14	10
55520 00 003	6	1/8	16.5	13	21.5	12.5	10
55520 00 004	6	1/4	18.5	15.5	24.5	14	10
55520 00 005	6	3/8	22	13.5	25	12.5	10
55520 00 006	8	1/4	18.5	15.5	24.5	14	10
55520 00 007	8	3/8	22	19	28	17	10
55520 00 008	10	3/8	22	19	28	17	10

55410

VITE CAVA SINGOLA
 BANJO STEM SINGLE
 EINFACHE HOHLSCHRAUBE
 VIS POUR BANJO SIMPLE
 TORNILLO SIMPLE
 HASTE PARA CONEXÃO BANJO COM 1 CAVIDADE

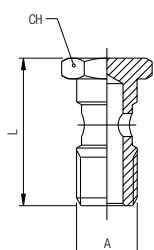

Code	A	L	CH	Pack.
55410 00 01 B5 NB	M5	22	8	10
55410 00 01 B8 NB	M6	23	8	10
55410 00 01 02 NB	1/8	28	14	10
55410 00 01 03 NB	1/4	32	17	10
55410 00 01 04 NT	3/8	36	19	10
55410 00 01 05 NT	1/2	42	24	10
55410 00 01 D6 NT	*M12x1.5	32	17	10

* Con questa vite utilizzare gli anelli orientabili da 1/4.

* With this banjo stem using 1/4 orienting banjo body.

* Bei dieser größe können dichterungen für 1/4 eingesetzt werden.

* Compatible avec joint 1/4.

* Con este tornillo utilizar el anillo orientable de 1/4.

* Com esta haste para banjo utilizar os anéis orientáveis de 1/4.

55420

VITE CAVA DOPPIA

BANJO STEM DOUBLE
 DOPPELTE HOHLSCHRAUBE
 VIS DOUBLE POUR BANJO
 TORNILLO DOBLE
 HASTE PARA CONEXÃO BANJO COM 2 CAVIDADES

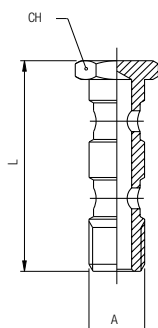

Code	A	L	CH	Pack.
55420 00 01 02 NT	1/8	44.5	14	10
55420 00 01 03 NT	1/4	50.5	17	10
55420 00 01 04 NT	3/8	58	19	10
55420 00 01 05 NT	1/2	68	24	10
55420 00 01 D6 NT *M12x1.5		50.5	17	10

* Con questa vite utilizzare gli anelli orientabili da 1/4.
 * With this banjo stem using 1/4 orienting banjo body.
 * Bei dieser größe können dichtringe für 1/4 eingesetzt werden.
 * Compatible avec joint 1/4.
 * Con este tornillo utilizar el anillo orientable de 1/4.
 * Com esta haste para banjo utilizar os anéis orientáveis de 1/4.

55430

VITE CAVA TRIPLA

BANJO STEM TRIPLE
 DREIFACH HOHLSCHRAUBE
 VIS TRIPLE POUR BANJO
 TORNILLO TRIPLE
 HASTE PARA CONEXÃO BANJO COM 3 CAVIDADES

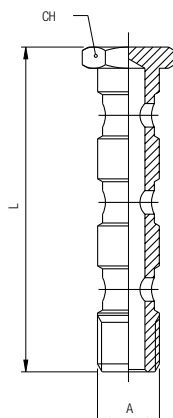

Code	A	L	CH	Pack.
55430 00 01 02 NT	1/8	61	14	10
55430 00 01 03 NT	1/4	69	17	10
55430 00 01 04 NT	3/8	80	19	10
55430 00 01 05 NT	1/2	94	24	10

55440

VITE CAVA SINGOLA MASCHIO - FEMMINA

MALE - FEMALE BANJO STEM SINGLE
 AUFSCRAUBHOHLSCHRAUBE MIT INNENGEWINDE
 VIS SIMPLE CREUSE TARAUDÉE POUR BANJO
 TORNILLO SIMPLE MACHO - HEMBRA
 HASTE PARA CONEXÃO BANJO COM 1 CAVIDADE MACHO - FÊMEA

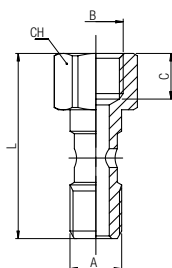

Code	A	B	C	L	CH	Pack.
55440 00 01 02 NB	1/8	1/8	8.5	34.5	14	10
55440 00 01 03 NB	1/4	1/4	11	40.5	17	10
55440 00 01 04 NB	3/8	3/8	12	45.5	19	10

ESEMPI DI ASSEMBLAGGIO DELLE VITI CON ANELLI ORIENTABILI SINGOLI E DOPPI.

ASSEMBLING EXAMPLES OF VARIOUS BANJO STEMS WITH SINGLE AND DOUBLE BANJO BODIES.

MONTAGEBEISPIELE VON HOHLSCHRAUBEN MONTIERT MIT EINFACHEN- UND DOPPELTEN RINGANSCHLÜSSEN.

EXEMPLES D'ASSEMBLAGES DES CORPS SIMPLES ET DOUBLES.

EJEMPLO DE MONTAJE DEL TORNILLO CON EL ANILLO ORIENTABLE SIMPLE Y DOBLE.

EXEMPLOS DE MONTAGEM DOS BANJOS COM ANÉIS ORIENTÁVEIS SIMPLES E DUPLOS.



Vite cava singola
Banjo stem single
Einfache hohlschraube
Vis pour banjo simple
Tornillo simple
Haste p/ banjo c/ 1 cavidade

Vite cava doppia
Banjo stem double
Doppelte hohlschraube
Vis double pour banjo
Tornillo doble
Haste p/ banjo c/ 2 cavidades

Vite cava tripla
Banjo stem triple
Dreifache hohlschraube
Vis triple pour banjo
Tornillo triple
Haste p/banjo c/ 3 cavidades

50600

ADATTATORE MASCHIO CILINDRICO

MALE ADAPTOR PARALLEL

EINSCHRAUBSTECKVERSCHRAUBUNG ZYLINDRISCH

ADAPTATEUR ENCLIQUETABLE MÂLE, CYLINDRIQUE

ADAPTADOR MACHO CILÍNDRICO CON TÓRICA

ADAPTADOR MACHO COM ROSCA PARALELA

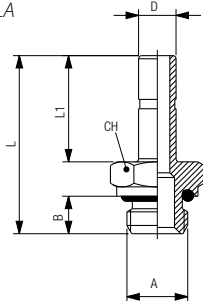

Code	D	A	B	L	L1	CH	Pack.
50600 00 001	4	M5	4	24	15	8	10
50600 00 002	4	1/8	6	26.5	15	13	10
50600 00 012	5	M5	4	26	17	8	10
50600 00 013	5	1/8	6	28.5	17	13	10
50600 00 014	5	1/4	8	31	17	16	10
50600 00 015	6	M5	4	26	17	8	10
50600 00 003	6	1/8	6	28.5	17	13	10
50600 00 004	6	1/4	8	31	17	16	10
50600 00 005	8	1/8	6	29.5	18	13	10
50600 00 006	8	1/4	8	32	18	16	10
50600 00 007	8	3/8	9	33.5	18	20	10
50600 00 016	10	1/8	6	33.5	22	13	10
50600 00 008	10	1/4	8	36	22	16	10
50600 00 009	10	3/8	9	37.5	22	20	10
50600 00 017	10	1/2	10	39.5	22	24	10
50600 00 010	12	1/4	8	38.5	24.5	16	10
50600 00 011	12	3/8	9	40	24.5	20	10
50600 00 018	14	1/2	10	44	26.5	24	10

50610

TAPPO IN POLIAMIDE

POLYAMIDE PLUG

VERSCHLUSSZAPFEN POLYAMID

BOUCHON EN POLYAMIDE

TAPÓN EN POLIAMIDA

TAMPÃO EM POLIAMIDA

New

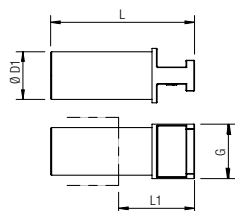

Code	ØD1	G	L	L1	Pack.
50610 00 31 X0 RO	3	5	30.5	18	10
50610 00 31 X1 RO	4	6	29.5	15.5	10
50610 00 31 X3 RO	5	7	33.5	18	10
50610 00 31 X4 RO	6	8	32	15.5	10
50610 00 31 X7 RO	8	10	35.5	19.5	10
50610 00 31 X9 RO	10	12	40	19.5	10
50610 00 31 Y1 RO	12	14	41.5	20	10
50610 00 31 Y3 RO	14	16	42	19.5	10
50610 00 31 Y5 RO	16	18	43.5	19.5	10

50615

COPERTURA COLORATA PER SPINTORE

COLORED RELEASE BOTTON COVERS

ABDECKRINGE MEHRFARBIG

CACHE POUSSOIR

FUNDAS PARA ANILLOS COLORADOS

CAPA COLORIDA PARA ANILHA DE LIBERACAO



Code	Colore					Tube	Pack.
	Color	Farbe	Couleur	Color	Cor		
50615 00 A7 X1	BN	BL	GI	RO	VE	4	10
50615 00 A7 X4	BN	BL	GI	RO	VE	6	10
50615 00 A7 X7	BN	BL	GI	RO	VE	8	10
50615 00 A7 X9	BN	BL	GI	RO	VE	10	10
50615 00 A7 Y1	BN	BL	GI	RO	VE	12	10
50615 00 A7 Y3	BN	BL	GI	RO	VE	14	10

55620

TAPPO TERMINALE

TERMINAL PLUG

VERSCHLUSSKAPPEN

BOUCHON TERMINAL

TAPÓN TERMINAL

TAMPA FINAL

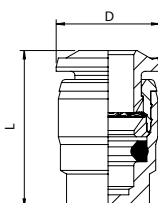

Code	Tube	D	L	Pack.
55620 00 002	4	10	18	10
55620 00 004	6	12.5	20	10
55620 00 005	8	14	21.5	10
55620 00 006	10	17	25	10
55620 00 007	12	20	27.5	10
55620 00 008	14	21	26.5	10

50625

GIUNZIONE DOPPIA

DOUBLE JOINT

DOPPELSTECKER

JONCTION DOUBLE

UNIÓN DOBLE

JUNÇÃO DUPLA

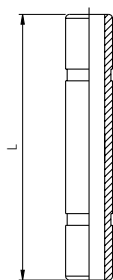

Code	Tube	L	Pack.
50625 00 01 X1 NB	4	31	10
50625 00 01 X3 NB	5	33	10
50625 00 01 X4 NB	6	34	10
50625 00 01 X7 NB	8	36	10
50625 00 01 X9 NB	10	45	10
50625 00 01 Y1 NB	12	50	10

55625

GIUNZIONE DOPPIA

DOUBLE JOINT

DOPPELSTECKER

JONCTION DOUBLE (TECHNOPOLYMÈRE)

UNIÓN DOBLE

JUNÇÃO DUPLA

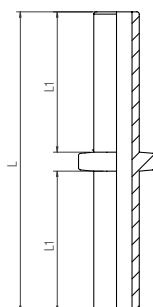

Code	Tube	L	L1	Pack.
55625 00 31 X1 NE	4	34.5	16	10
55625 00 31 X4 NE	6	39.5	18.5	10
55625 00 31 X7 NE	8	42	19.5	10
55625 00 31 X9 NE	10	51.5	24	10
55625 00 31 Y1 NE	12	60	28	10
55625 00 31 Y3 NE	14	69.5	33	10

50700N

RIDUZIONE

REDUCER
 REDUZIERUNG
 RÉDUCTION ENCLIQUETABLE
 REDUCCIÓN
 REDUÇÃO

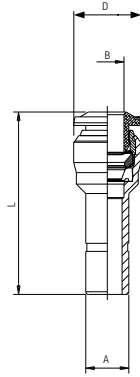

Code	A	B	L	D	Pack.
50700 00 N06	4	3	30	8.5	10
50700 00 N04	5	4	32	11.5	10
50700 00 N01	6	4	30	10.5	10
50700 00 N05	6	5	34.5	11.5	10
50700 00 N08	8	4	32.5	10.5	10
50700 00 N02	8	6	34.5	12.5	10
50700 00 N09	10	4	31.5	10.5	10
50700 00 N11	10	6	37.5	12.5	10
50700 00 N03	10	8	38.5	14.5	10
50700 00 N07	12	8	39.5	14.5	10
50700 00 N10	12	10	43	17.5	10

55700

RIDUZIONE

REDUCER
 REDUZIERUNG
 RÉDUCTION ENCLIQUETABLE (TECHNOPOLYMÈRE)
 REDUCCION
 REDUÇÃO

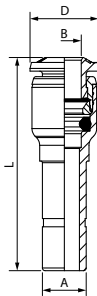

Code	A	B	L	D	Pack.
55700 00 001	6	4	34	10	10
55700 00 008	8	4	38.5	12	10
55700 00 002	8	6	39	12.5	10
55700 00 011	10	6	49.5	14	10
55700 00 003	10	8	42	14	10
55700 00 013	12	6	38.5	12.5	10
55700 00 007	12	8	41.5	14	10
55700 00 010	12	10	48.5	17	10
55700 00 014	14	8	37.5	14	10
55700 00 015	14	10	49.5	20	10
55700 00 012	14	12	50	20	10

55705

RIDUZIONE

REDUCER
 REDUZIERUNG
 RÉDUCTION ENCLIQUETABLE (TECHNOPOLYMÈRE)
 REDUCCION
 REDUÇÃO

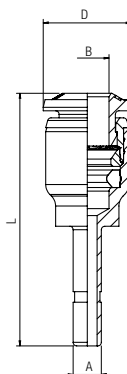

Code	A	B	L	D	Pack.
55705 00 001	4	6	36	12	10
55705 00 002	6	8	38.5	14	10
55705 00 003	8	10	43	17	10
55705 00 004	10	12	48	20	10

55800N

CARTUCCE A COMPRESIONE

PUSH-FIT CARTRIDGES

EINPRESSPATRONEN

CARTOUCHE

CARTUCHO A COMPRESIÓN

CARTUCHO DE COMPRESSÃO

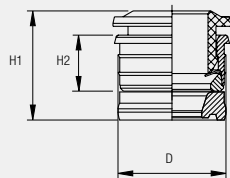

Code	Tube	D	H1	H2	Pack.
55800 00 N08	3	6.7	9	5	25
55800 00 N01	4	8.7	11	5.6	25
55800 00 N02	5	9.75	11.8	6.3	25
55800 00 N03	6	10.75	12.4	6.9	25
55800 00 N04	8	12.7	12.4	6.9	25
55800 00 N05	10	15.7	15.7	8.5	25
55800 00 N06	12	18.3	17.8	9.5	25

SEDE

SEAT

BOHRUNGEN

IMPLANTATION

SEDE

SEDE

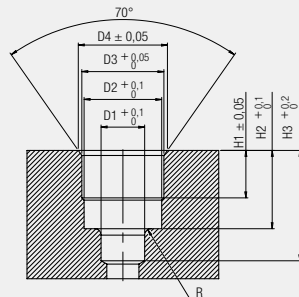

Dimensioni sedi cartucce a compressione.

Seats dimensions push-fit cartridges.

Bohrungsangaben für die einpresspatronen.

Dimensions des logements des cartouches.

Dimensiones sede cartucho a compresión.

Dimensão da sede do cartucho de compressão.

Tube	D1	D2	D3	D4	H1	H2	H3	R
3	3.4	6.05	6.4	6.95	3.7	6.1	8.6	0.5
4	4.2	7.45	8.4	9	3.75	6.5	9.5	0.5
5	5.2	8.35	9.4	10.15	4.45	7.9	10.5	0.5
6	6.2	9.35	10.45	11.35	5	8.5	11.5	0.5
8	8.2	11.4	12.4	12.9	5.2	8.5	12.5	0.75
10	10.2	14.5	15.4	16	6.7	10.5	15	0.75
12	12.2	17	18	19	7.5	12.1	17	1

ISTRUZIONI DI MONTAGGIO CARTUCCE A COMPRESIONE ART. 55800N

PUSH-FIT CARTRIDGES ASSEMBLING INSTRUCTIONS ART. 55800N

ANLEITUNG FÜR DIE MONTAGE DER EINPRESSPATRONEN ART. 55800N

INSTRUCTION DE MONTAGE POUR CARTOUCHE RÉF. 55800N

INSTRUCCIONES DE MONTAJE CARTUCHO A COMPRESIÓN ART. 55800N

INSTRUÇÕES DE MONTAGEM DO CARTUCHO DE COMPRESSÃO CÓD. 55800N

1

Realizzare la sede per la cartuccia utilizzando l'apposita fresa Art. 55801.

Make the seat for the cartridge utilizing the suitable tool Art. 55801.

Machen sie die Sitze für die Einpresspatronen mit dem entsprechenden Stufenbohrer Art. 55801.

Usiner le logement de la cartouche à l'aide de l'outil de perçage réf. 55801.

Realizar la sede para el cartucho utilizando la correspondiente fresa Art. 55801.

Realize a furação da sede para o cartucho utilizando a fresa de cód. 55801.



2

Inserire la guarnizione sagomata nell'apposita sede.

Insert the seal inside of the seat.

Legen sie die dichtung in die Bohrung ein.

Insérer le joint dans le logement.

Insertar la junta en la correspondiente sede.

Insira vedação no fundo da sede.



3

Inserire la cartuccia nel canotto di montaggio Art. 55802.

Insert the cartridge into the assembling tool Art. 55802.

Legen sie die Einpresspatrone in das Montage-werkzeug Art. 55802.

Insérer la cartouche dans l'outil de montage réf. 55802.

Insertar el cartucho en el útil de montaje Art. 55802.

Insira o cartucho no tubete de montagem Cód. 55802.



4

Premere la cartuccia all'interno della sede fino ad arrivare in battuta sul piano con il canotto.

Press the cartridge inside of the seat until it will be reached the abutment surface with the assembling tool.

Drücken sie die Einpresspatrone in die Bohrung, bis das Montagewerkzeug am Werkstück ansteht.

Presser la cartouche dans le logement jusqu'à ce que l'outil de montage soit en contact avec la surface.

Empujar el cartucho al interior de la sede hasta llegar al plano con el útil de montaje.

Pressione o cartucho no interior da sede até tocar a superfície de montagem com o tubete.



55801

FRESA SEDE CARTUCCE A COMPRESSIONE

TOOL FOR PUSH-FIT CARTRIDGES SEAT

STUFENBOHRER FÜR EINPRESSPATRONEN

OUTIL DE PERÇAGE POUR CARTOUCHE

FRESA SEDE CARTUCHO A COMPRESIÓN

FRESA PARA FURAÇÃO DA SEDE DO CARTUCHO DE COMPRESSÃO



Code	Tube	ø Body	Pack.
55801 00 007	3	10	1
55801 00 001	4	10	1
55801 00 006	5	12	1
55801 00 002	6	12	1
55801 00 003	8	12	1
55801 00 004	10	16	1
55801 00 005	12	16	1

55802

CANOTTO MONTAGGIO CARTUCCE A COMPRESSIONE

ASSEMBLING TOOL FOR PUSH-FIT CARTRIDGES

MONTAGWERKZEUG FÜR EINPRESSPATRONEN

OUTIL DE MONTAGE POUR CARTOUCHE

ÚTIL DE MONTAJE CARTUCHO A COMPRESIÓN

TUBETE PARA MONTAGEM DO CARTUCHO DE COMPRESSÃO



Code	Tube	Pack.
55802 00 001	3	1
55802 00 002	4	1
55802 00 003	5	1
55802 00 004	6	1
55802 00 005	8	1
55802 00 006	10	1
55802 00 007	12	1

50900N

RIPARTITORE IN ALLUMINIO A 5 VIE

ALUMINIUM MANIFOLD 5 WAYS
ALUMINIUM-VERTEILER MIT 5 AUSGÄNGEN
BLOQUE DE DISTRIBUTION EN ALUMINIUM (5 SORTIES)
REGLETA EN ALUMINIO A 5 VIAS
DISTRIBUIDOR EM ALUMÍNIO DE 5 VIAS

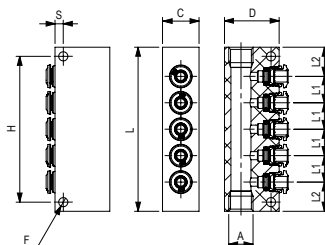

Code	Tube	A	H	F	C	S	D	L	L1	L2	Pack.
50900 00 N01	4	1/8	66	5	15	4.5	25	75	12	13.5	5
50900 00 N02	6	1/8	80	5	15	4.5	25	90	14.5	16	5
50900 00 N03	6	1/4	80	5	20	4.5	30	90	14.5	16	5
50900 00 N04	8	1/4	90	5	20	4.5	30	100	16	18	5

50980

CLIP DI SICUREZZA

SECURITY CLIPS
SICHERHEITSCLIP
CLIP DE SECURITÉ
CLIP DE SEGURIDAD ROJO
CLIP DE SEGURANÇA

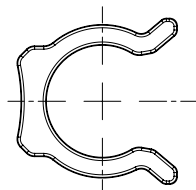

Code	Tube	Pack.
50980 00 32 X1 RO	4 (5/32)	50
50980 00 32 X3 RO	5	50
50980 00 32 X4 RO	6 (1/4)	50
50980 00 32 X7 RO	8 (5/16)	50
50980 00 32 X9 RO	10 (3/8)	50
50980 00 32 Y1 RO	12 (1/2)	50
50980 00 32 Y3 RO	14	50

50990

LEVA SGANCIO ADATTATORI

TOOL FOR DISASSEMBLING
LÖSEWERKZEUG
OUTIL DE DÉMONTAGE
LLAVE DE DESMONTAJE
FERRAMENTA PARA DESMONTAGEM

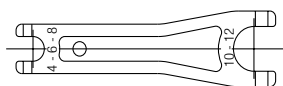

Code	Pack.
50990 00 001	10

50006

ANELLO DI TENUTA PER FILETTI CONICI "UNIVERSAL SHORT"

THREAD PACKING FOR THE "UNIVERSAL SHORT" TAPER THREADS
DICHRINGE FÜR KONISCHE GEWINDE "UNIVERSAL SHORT"
BAGUE D'ÉTANCHÉITÉ POUR FILETAGES CONIQUES "UNIVERSAL SHORT"
JUNTA DE CIERRE PARA ROSCAS CÓNICAS "UNIVERSAL SHORT"
ANEL DE VEDAÇÃO PARA ROSCAS CÔNICA "UNIVERSAL SHORT"



Code	Thread	Pack.
50006 00 24 02 00	1/8	10
50006 00 24 03 00	1/4	10
50006 00 24 04 00	3/8	10
50006 00 24 05 00	1/2	10

SERIE 56000 "MINI"

LEGENDA
KEY
LEGENDE
LEGENDE
LEYENDA
LEGENDA



Regolazione a cacciavite - Screwdriver regulation - Einstellbar mit schraubenzieher
A vis noyée - Regulación a destornillador - Regulagem por parafuso



Regolazione manuale - Manual regulation - Einstellbar von hand
Réglage manuel - Regulación manual - Regulagem manual

56010

RACCORDO DIRITTO MASCHIO CILINDRICO ESAGONO INCASSATO

STRAIGHT MALE ADAPTOR (PARALLEL) WITH EXAGON EMBEDDED
GERADE EINSCHRAUBVERSCHRAUBUNG MIT INNENSECHSKANT ZYLINDRISCH
RACCORD DROIT MÂLE, CYLINDRIQUE, 6-PANS INTERIEUR
RACOR RECTO MACHO CILÍNDRICO CON TÓRICA HEXÁGONO INTERIOR
CONEXÃO RETA COM SEXTAVADO INTERNO E ROSCA MÉTRICA

Code	Tube	A	B	H	D	CH	Pack.
56010 00 006	4	M3	3	15	8	1.5	10
56010 00 001	4	M5	3.6	14	8.5	2.5	10
56010 00 002	4	M7	5	14	10	3	10
56010 00 003	6	M5	3.6	16	10	2.5	10
56010 00 004	6	M7	5	16	10	4	10

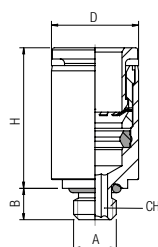

56020

RACCORDO DIRITTO MASCHIO CILINDRICO

STRAIGHT MALE ADAPTOR (PARALLEL)
GERADE EINSCHRAUBVERSCHRAUBUNG ZYLINDRISCH
RACCORD DROIT MÂLE, CYLINDRIQUE
RACOR RECTO MACHO CILÍNDRICO CON TÓRICA
CONEXÃO RETA COM ROSCA PARALELA

Code	Tube	A	B	H	CH1	CH2	Pack.
56020 00 001	2	M3	3	11	6	1.5	10
56020 00 002	2	M5	4	9	7	1.5	10
56020 00 003	3	M3	3	11	6	1.5	10
56020 00 004	3	M5	4	10	7	2	10
56020 00 005	4	M3	3	14.5	8	/	10
56020 00 006	4	M5	3.6	14	9	2.5	10
56020 00 007	4	M7	5	14	10	3	10
56020 00 008	4	1/8	5	11.5	13	3	10
56020 00 009	6	M5	3.6	16	11	2.5	10
56020 00 010	6	M7	5	16	10	3	10
56020 00 011	6	1/8	5	13.5	13	4	10
56020 00 012	6	1/4	7.1	12	16	4	10

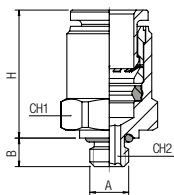

56040

RACCORDO DIRITTO INTERMEDIO

STRAIGHT CONNECTOR
VERBINDUNGSVERSCHRAUBUNG
RACCORD UNION DOUBLE
RACOR RECTO INTERMEDIO
CONEXÃO RETA TUBO-TUBO

Code	A	B	C	D	L	Pack.
56040 00 003	4	4	8.5	8.5	25	10
56040 00 004	6	6	10.5	10.5	28	10
56040 00 005	8	6	10.5	14	34.5	10

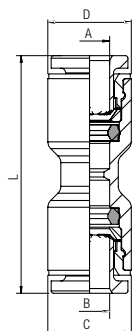

56050

RACCORDO DIRITTO INTERMEDIO DI ATTRAVERSAMENTO

BULKHEAD CONNECTOR
SCHOTTVERSCHRAUBUNG
RACCORD TRAVERSÉE DE CLOISON
RACOR RECTO INTERMEDIO PASATABIQUES
CONEXÃO PASSA-MURO RETA TUBO-TUBO

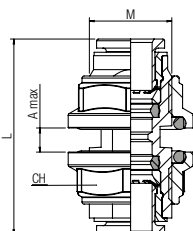

Code	Tube	M	L	CH	A max	Pack.
56050 00 003	4	M10x1	25	13	5.5	10
56050 00 004	6	M12x1	28	15	8.5	10

56115

RACCORDO A L ORIENTABILE MASCHIO CILINDRICO

ORIENTING ELBOW MALE ADAPTOR (PARALLEL)
WINKELVERSCHRAUBUNG ZYLINDRISCH (DREHBAR)
EQUERRE MÂLE ORIENTABLE, CYLINDRIQUE
RACOR A L ORIENTABLE MACHO CILÍNDRICO
CONEXÃO MACHO EM "L" ORIENTÁVEL COM ROSCA PARALELA

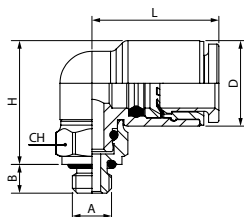

Code	Tube	A	B	H	L	D	CH	Pack.
56115 00 001	2	M3	3	13	11	6.5	8	10
56115 00 002	2	M5	4	12.5	11	6.5	8	10
56115 00 003	3	M3	3	13	11	6.5	8	10
56115 00 004	3	M5	4	12.5	11	6.5	8	10
56115 00 013	4	M3	3	10	14	8.5	8	10
56115 00 005	4	M5	3.6	13.5	14	8.5	8	10
56115 00 006	4	1/8	5	13	14	8.5	13	10
56115 00 007	4	1/4	7.1	13	14	8.5	16	10
56115 00 008	6	M5	3.6	15.5	16	10.5	8	10
56115 00 011	6	M7x1	5	16	16	10.5	9	10
56115 00 009	6	1/8	5	15	16	10.5	13	10
56115 00 010	6	1/4	7.1	15	16	10.5	16	10

56130

RACCORDO A L INTERMEDIO

EQUAL ELBOW
WINKELVERSCHRAUBUNG
RACCORD EQUERRE
RACOR A L INTERMEDIO
CONEXÃO EM "L" TUBO-TUBO

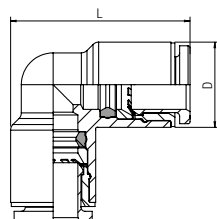

Code	Tube	L	D	Pack.
56130 00 001	2	14.5	6.5	10
56130 00 002	3	14.5	6.5	10
56130 00 003	4	19	8.5	10
56130 00 004	6	22.5	10.5	10

56215

RACCORDO A T ORIENTABILE MASCHIO CILINDRICO

ORIENTING TEE MALE ADAPTOR (PARALLEL) – CENTRE LEG

T-EINSCHRAUBVERSCHRAUBUNG ZYLINDRISCH (DREHBAR)

TÉ ORIENTABLE À PIQUAGE MÂLE CENTRAL, CYLINDRIQUE

RACOR A T ORIENTABLE MACHO CENTRAL CILÍNDRICO

CONEXÃO MACHO EM "T" ORIENTÁVEL COM ROSCA PARALELA

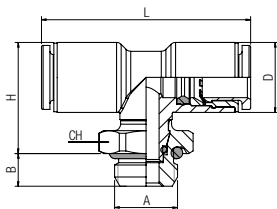

Code	Tube	A	B	H	L	D	CH	Pack.
56215 00 001	2	M3	3	13	22	6.5	8	10
56215 00 002	2	M5	4	12.5	22	6.5	8	10
56215 00 003	3	M3	3	13	22	6.5	8	10
56215 00 004	3	M5	4	12.5	22	6.5	8	10

56225

RACCORDO A T ORIENTABILE MASCHIO LATERALE CILINDRICO

ORIENTING TEE MALE ADAPTOR (PARALLEL) – OFF-SET LEG

L-EINSCHRAUBVERSCHRAUBUNG ZYLINDRISCH (DREHBAR)

TÉ ORIENTABLE À PIQUAGE LATÉRAL, CYLINDRIQUE

RACOR A T ORIENTABLE MACHO LATERAL CILÍNDRICO

CONEXÃO MACHO EM "T" LATERAL ORIENTÁVEL COM ROSCA PARALELA

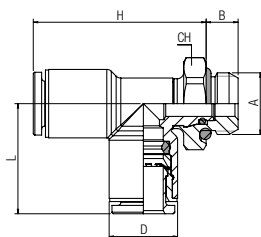

Code	Tube	A	B	H	L	D	CH	Pack.
56225 00 001	2	M3	3	21	11	6.5	8	10
56225 00 002	2	M5	4	21	11	6.5	8	10
56225 00 003	3	M3	3	21	11	6.5	8	10
56225 00 004	3	M5	4	21	11	6.5	8	10

56230

RACCORDO A T INTERMEDIO

TEE CONNECTOR

T-ANSCHLUSS

RACCORD TÉ

RACOR A T INTERMEDIO

CONEXÃO EM "T" TUBO-TUBO

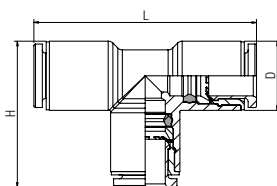

Code	Tube	H	L	D	Pack.
56230 00 001	2	14.5	22	6.5	10
56230 00 002	3	14.5	22	6.5	10
56230 00 003	4	19	29	8.5	10
56230 00 004	6	22.5	34.5	10.5	10

56550

RACCORDO ORIENTABILE A L

ORIENTING SINGLE BANJO BODY MALE

WINKELSCHWENKVERSCHRAUBUNG (DREHBAR)

EQUERRE MÂLE BANJO, ORIENTABLE

RACOR ORIENTABLE SIMPLE

CONEXÃO BANJO EM "L"

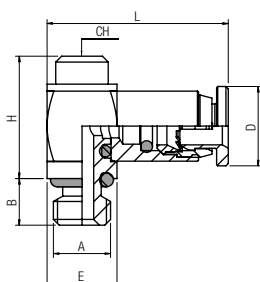

Code	Tube	A	B	H	L	E	D	CH	Pack.
56550 00 003	3	M3	3	10.5	15.5	6	7	2	10
56550 00 004	3	M5	4	10.5	15.5	6	7	2	10

56900



**REGOLATORE UNIDIREZIONALE ORIENTABILE
PER CILINDRO FILETTO CILINDRICO**

ORIENTING FLOW REGULATOR FOR CYLINDER (PARALLEL)
 DURCHFLUSSREGLER ABLUFTDROSSELUNG (DREHBAR) MIT ZYL. GEWINDE
 RÉGLEUR A L'ÉCHAPPEMENT FILETAGE CYLINDRIQUE
 REGULADOR UNIDIRECCIONAL ORIENTABLE PARA CILINDRO ROSCA CILÍNDRICA
 REGULADORA PARA CILINDRO UNIDIRECCIONAL ORIENTÁVEL COM ROSCA PARALELA

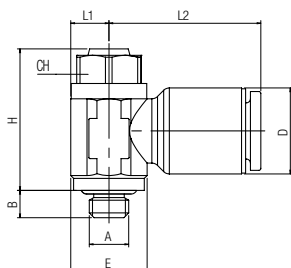
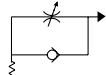

Code	Tube	A	B	H	E	L1	L2	D	CH	Pack.
56900 00 001	4	M5	3.6	18	9.5	4.5	16.5	8.5	8	10
56900 00 002	6	M5	3.6	18	9.5	4.5	19	10.5	8	10

56910



**REGOLATORE UNIDIREZIONALE ORIENTABILE
PER VALVOLA FILETTO CILINDRICO**

ORIENTING FLOW REGULATOR FOR VALVE (PARALLEL)
 DURCHFLUSSREGLER ZULUFTDROSSELUNG (DREHBAR) MIT ZYL. GEWINDE
 RÉGLEUR A L'ADMISSION FILETAGE CYLINDRIQUE
 REGULADOR UNIDIRECCIONAL ORIENTABLE PARA VÁLVULA ROSCA CILÍNDRICA
 REGULADORA PARA VÁLVULA UNIDIRECCIONAL ORIENTÁVEL COM ROSCA PARALELA

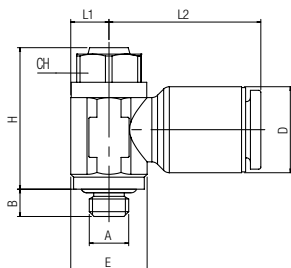
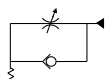

Code	Tube	A	B	H	E	L1	L2	D	CH	Pack.
56910 00 001	4	M5	3.6	18	9.5	4.5	16.5	8.5	8	10
56910 00 002	6	M5	3.6	18	9.5	4.5	19	10.5	8	10

56920



REGOLATORE BIDIREZIONALE ORIENTABILE FILETTO CILINDRICO

ORIENTING BI-DIRECTIONAL FLOW REGULATOR (PARALLEL)
 DURCHFLUSSREGLER BI-DIREKTIONAL (DREHBAR) MIT ZYL. GEWINDE
 RÉGLEUR BI-DIRECTIONNEL FILETAGE CYLINDRIQUE
 REGULADOR BIDIRECCIONAL ORIENTABLE ROSCA CILÍNDRICA
 REGULADORA BI-DIRECCIONAL ORIENTÁVEL COM ROSCA PARALELA

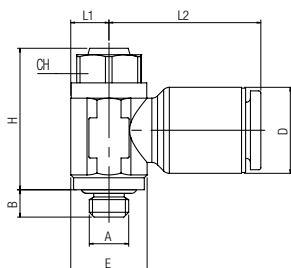

Code	Tube	A	B	H	E	L1	L2	D	CH	Pack.
56920 00 001	4	M5	3.6	18	9.5	4.5	16.5	8.5	8	10
56920 00 002	6	M5	3.6	18	9.5	4.5	19	10.5	8	10

56935



**REGOLATORE UNIDIREZIONALE ORIENTABILE
PER CILINDRO FILETTO CILINDRICO**

ORIENTING FLOW REGULATOR FOR CYLINDER (PARALLEL)
DURCHFLOSSREGLER ABLUFTDROSSELUNG (DREHBAR) MIT ZYL. GEWINDE
RÉGLEUR A L'ÉCHAPPEMENT FILETAGE CYLINDRIQUE
REGULADOR UNIDIRECCIONAL ORIENTABLE PARA CILINDRO ROSCA CILÍNDRICA
REGULADORA PARA CILINDRO UNIDIRECCIONAL ORIENTÁVEL COM ROSCA PARALELA

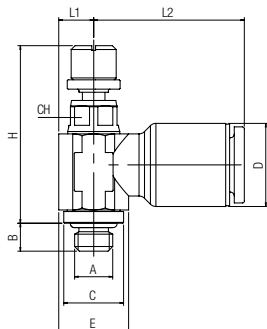
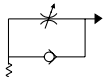

Code	Tube	A	B	H	E	C	L1	L2	D	CH	Pack.
56935 00 006	4	M3	3	21.5±24.5	9	7.5	4.5	17	8.5	6	10
56935 00 001	4	M5	3.6	21.5±24.5	9	7.5	4.5	17	8.5	6	10
56935 00 003	4	1/8	5	24±27.5	11.5	13.5	6.5	17	8.5	7	10
56935 00 002	6	M5	3.6	21.5±24.5	9	7.5	4.5	19.5	10.5	6	10
56935 00 004	6	1/8	5	24±27.5	11.5	13.5	6.5	19.5	10.5	7	10

56945



**REGOLATORE UNIDIREZIONALE ORIENTABILE
PER VALVOLA FILETTO CILINDRICO**

ORIENTING FLOW REGULATOR FOR VALVE (PARALLEL)
DURCHFLOSSREGLER ZULUFTDROSSELUNG (DREHBAR) MIT ZYL. GEWINDE
RÉGLEUR A L'ADMISSION FILETAGE CYLINDRIQUE
REGULADOR UNIDIRECCIONAL ORIENTABLE PARA VÁLVULA ROSCA CILÍNDRICA
REGULADORA PARA VÁLVULA UNIDIRECCIONAL ORIENTÁVEL COM ROSCA PARALELA

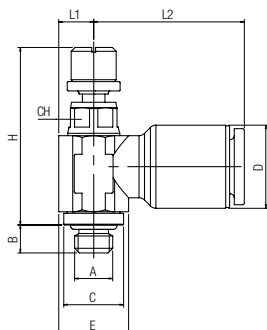
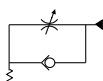

Code	Tube	A	B	H	E	C	L1	L2	D	CH	Pack.
56945 00 001	4	M5	3.6	21.5±24.5	9	7.5	4.5	17	8.5	6	10
56945 00 003	4	1/8	5	24±27.5	11.5	13.5	6.5	17	8.5	7	10
56945 00 002	6	M5	3.6	21.5±24.5	9	7.5	4.5	19.5	10.5	6	10
56945 00 004	6	1/8	5	24±27.5	11.5	13.5	6.5	19.5	10.5	7	10

56955



REGOLATORE BIDIREZIONALE ORIENTABILE FILETTO CILINDRICO

ORIENTING BI-DIRECTIONAL FLOW REGULATOR (PARALLEL)
DURCHFLOSSREGLER BI-DIREKTIONAL (DREHBAR) MIT ZYL. GEWINDE
RÉGLEUR BI-DIRECTIONNEL FILETAGE CYLINDRIQUE
REGULADOR BIDIRECCIONAL ORIENTABLE ROSCA CILÍNDRICA
REGULADORA BI-DIRECCIONAL ORIENTÁVEL COM ROSCA PARALELA

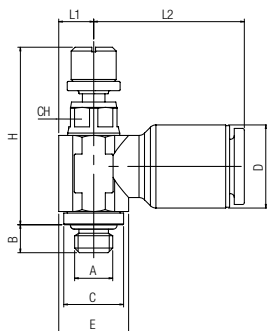
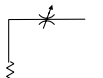

Code	Tube	A	B	H	E	C	L1	L2	D	CH	Pack.
56955 00 001	4	M5	3.6	21.5±24.5	9	7.5	4.5	17	8.5	6	10
56955 00 003	4	1/8	5	24±27.5	11.5	13.5	6.5	17	8.5	7	10
56955 00 002	6	M5	3.6	21.5±24.5	9	7.5	4.5	19.5	10.5	6	10
56955 00 004	6	1/8	5	24±27.5	11.5	13.5	6.5	19.5	10.5	7	10